



GEZE TSA 355/395 REVOLVING DOORS
FOCAL POINT OF THE ENTRANCE AREA



CONTENTS

Introduction	4
GEZE TSA 355 revolving door drive	6
GEZE TSA 395 revolving door drive	16
GEZE TSA 395 Multi revolving door drive	21
Certificates	26
References	28

GEZE revolving door systems

Focal point of the entrance area

The entrance area is the face of the building and thus of the enterprise. Therefore it is imperative to validate the positive visual impression through the faultless function of the door system even in the case of high access frequency. GEZE revolving doors meet these requirements and enthral planners, but also owners and users of buildings alike. The virtually unlimited design freedom and the complete selection of materials and colours meet the highest architectural requirements. Revolving doors also offer good protection against draught as they are open and closed at the same time. By eliminating draught in the entrance area, the immediate environment can be used commercially with noise, dust and dirt being kept out. The clear spatial separation between the interior and exterior as well as the energy savings offer significant cost advantages and make the use of revolving doors even more advantageous.

The scope of use of revolving doors is manifold. They are suitable for:

- Commercial buildings
- Public buildings
- Shopping centres
- Hotels and restaurants
- Administrative buildings
- Car dealerships
- Airports and railway stations

GEZE revolving doors are customised for each individual project. Various different options and versions are available. Please contact us if the variant you want differs from the dimensions and options mentioned. We offer a door for every entrance.



Tüyap Palace, Istanbul

Advantages for all target groups

Advantages for planners and builders:

- Design freedom and project specific customised planning with a range of options
- Commercial use of the entrance area for shops, offices, showrooms and a reception desk
- Harmonious visual appearance of the façade and interior
- Prestigious entrance with excellent visual effect
- Improvement of the building's energy balance
- Economical solution thanks to the high level of factory prefabrication

Advantages for users:

- Flawless and smooth operation of the door system even in the case of high access frequency.
- Easy setting of desired mode of operation
- Effective protection against noise, dust and dirt
- Protection against draught

Advantages for processors:

- Flexible modular system
- Easy installation thanks to the high level of factory prefabrication
- Predefined and programmed control technology for quick commissioning
- The door system and safety devices comply with the currently applicable standards and regulations



Latanya Otel, Ankara

GEZE TSA 355 revolving door drive

The versatile door drive

The TSA 355 model has a very wide range of applications and can be used universally. With a diameter ranging from 1800 mm to 400 mm and a manual version or a fully automatic drive, exactly the right variant is always available. The doors can be made individually in any desired diameter and passage height. A versatile selection is also available in the surface and colour design. The door is available in 3- or 4-leaf versions and offers an additional night-time closer.

The door system has been tested and certified according to EN 16005.

Thanks to the variant with optionally available folding leaves (break-out), revolving doors are also suitable for use in escape and rescue routes, depending on building regulations and the required width of the escape route. The TSA 355 door system is the optimal solution in buildings with low as well as high public access frequency.



Hotel Hilton Garden Inn, Ankara

Technical data

Standard features	
System	automatic
Emergency stop switch	one for each entrance and exit
Push pad	one for each entrance and exit
Manual operation	possible as an option
Radar movement detector	one for each entrance and exit
Front post safety sensor	one for each entrance and exit
Post safety	standard for each entrance
Curved glasses	8 mm LSG
Glass for leaves	8 mm LSG
Locking	manual locking/automatic locking
Roof	waterproof roof with waterspout
Brushes	40 mm horse hair brushes
Ceiling	12 segments made of 1.5 mm thick aluminium sheet
Glass seal	EPDM
Canopy	aluminium profile, canopy height 200 mm/300 mm possible (depending on diameter)
Colour	natural anodised or RAL colours
Illumination	4 x 10 W LED downlight
Control panel	control panel with position switch
Optional features	
Stainless steel cladding	•
Gold coloured stainless steel cladding	•
Entrance mat	•
Door handle	•
Coloured glass	•
Passage height in various dimensions	•
Canopy height in different dimensions	•
Night-time closer	•
Break-out leaves	•
Manual locking + switch	•
Waterproof roof for the exterior, with drain channel	•
2 pcs. downlights extra	•
20x30x2 mm stainless steel floor ring	•
Hot-air curtain	•
Control panel with touchscreen	•

Technical data



Standard

- Error detection combined with flashing LEDs
- On/off switch for lighting
- Programme switch for change between modes of operation Automatic, Manual and Night



Optional touch panel

- On/off switch for lighting
- Modes for testing and error detection
- Setting speed control and waiting periods
- Setting for limiting the torque
- Settings for stop and start periods
- All revolving door settings can be made using this touch screen



Post safety



Front post safety sensor



Access for people with disabilities and for the elderly



Light curtain



Push pad



Heel protection



Emergency stop switch

Technical data (4-leaf)

FRONTAL VIEW

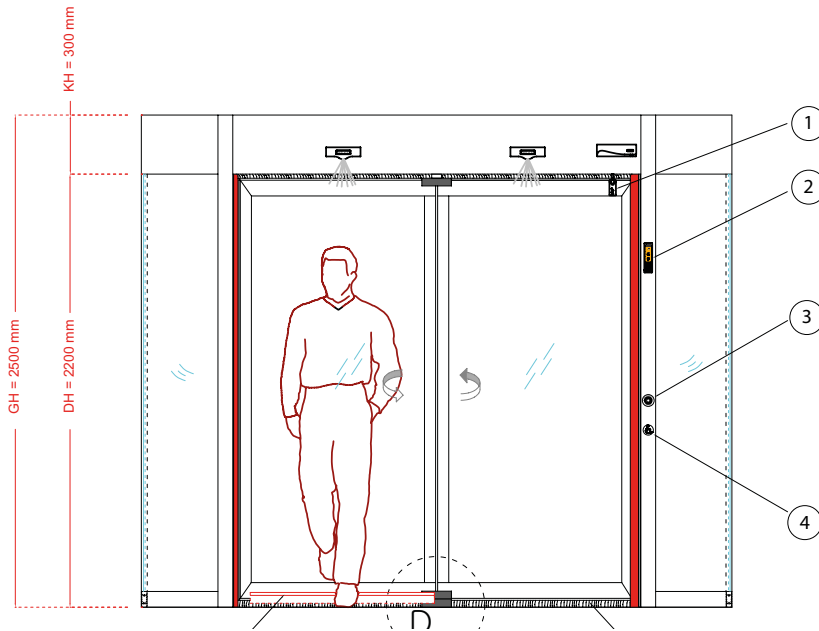

- | | |
|------------------------------------|---------------------|
| 1 = Manual locking | GH = Total height |
| 2 = Control panel/programme switch | DH = Passage height |
| 3 = Emergency stop switch | KH = Canopy height |
| 4 = Push pad | |
| 5 = Brush sealing | |
| 6 = Heel protection | |

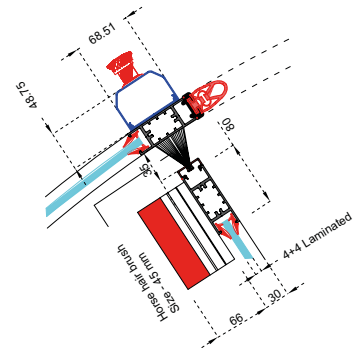

DETAIL A

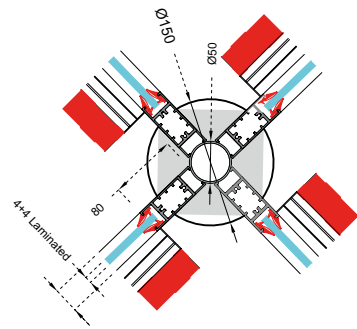

DETAIL B

PLAN VIEW

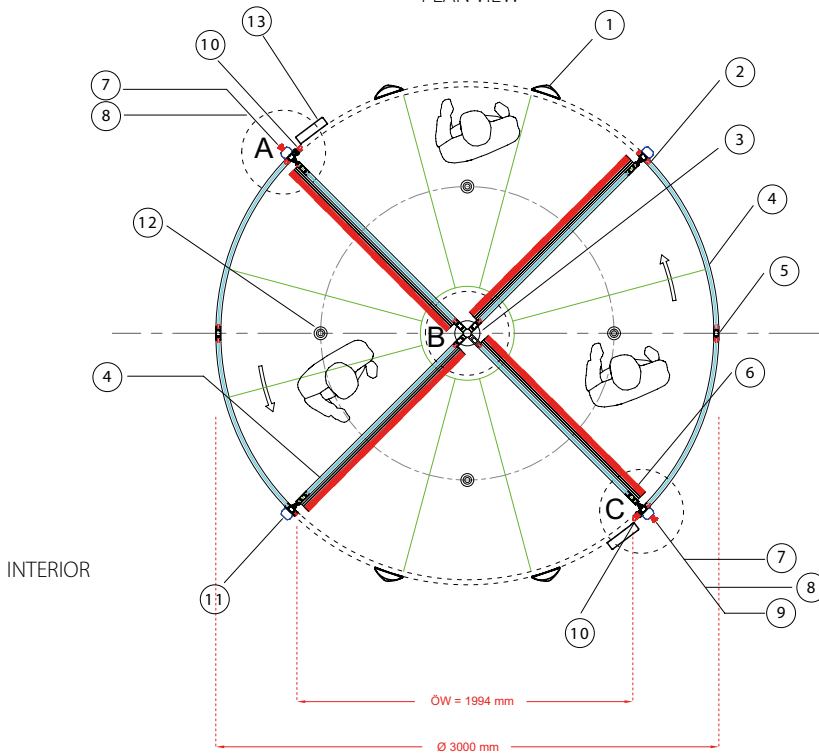

INTERIOR

- | | |
|--------------------------------|------------------------------------|
| 1 = Radar movement detector | 8 = Push pad |
| 2 = Glass sealing | 9 = Control panel/programme switch |
| 3 = Central shaft | 10 = Post safety |
| 4 = 8 mm LSG | 11 = Post attachment profile |
| 5 = 80x30 mm aluminium profile | 12 = 10 W LED |
| 6 = Heel protection | 13 = Front post safety sensor |
| 7 = Emergency stop switch | ÖW = Opening width |

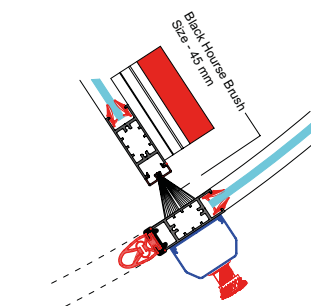

DETAIL C

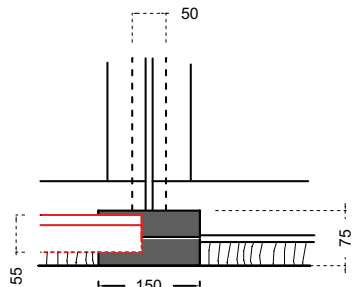

DETAIL D

Technical data (3-leaf)

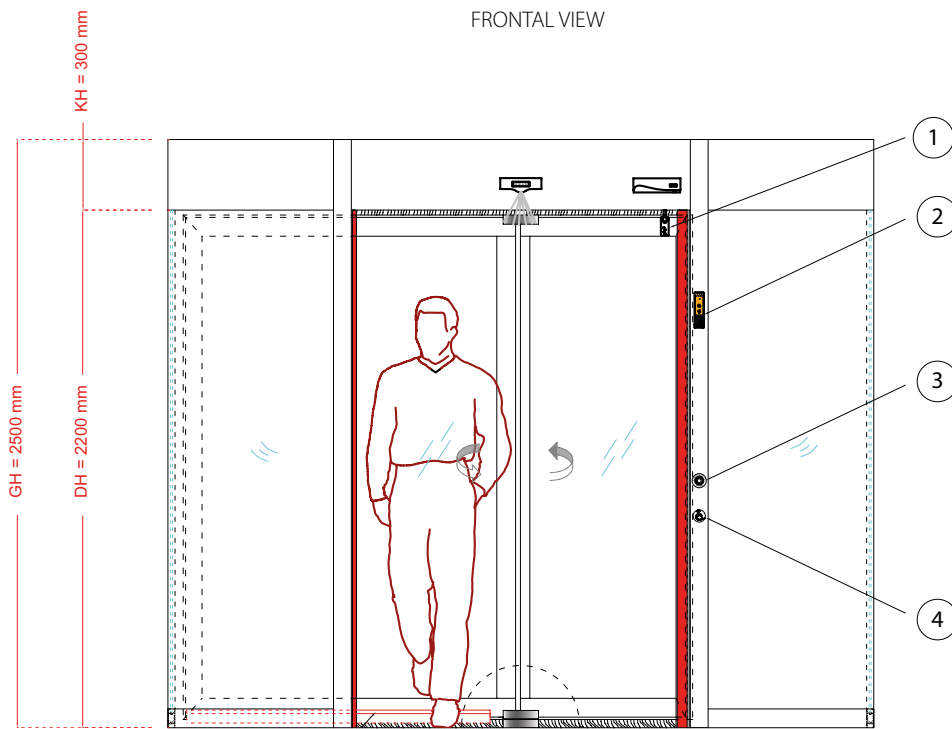

- 1 = Manual locking
 - 2 = Control panel/programme switch
 - 3 = Emergency stop switch
 - 4 = Push pad
 - 5 = Brush sealing
 - 6 = Heel protection
- GH = Total height
 DH = Passage height
 KH = Canopy height

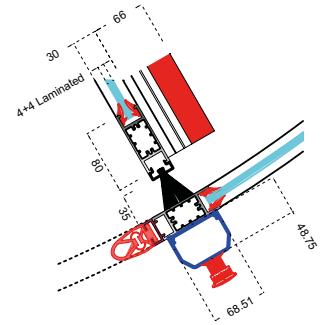

DETAIL A

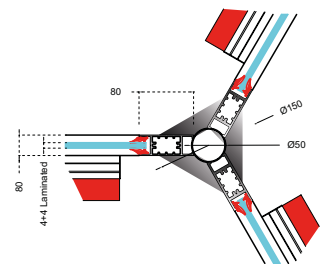

DETAIL B

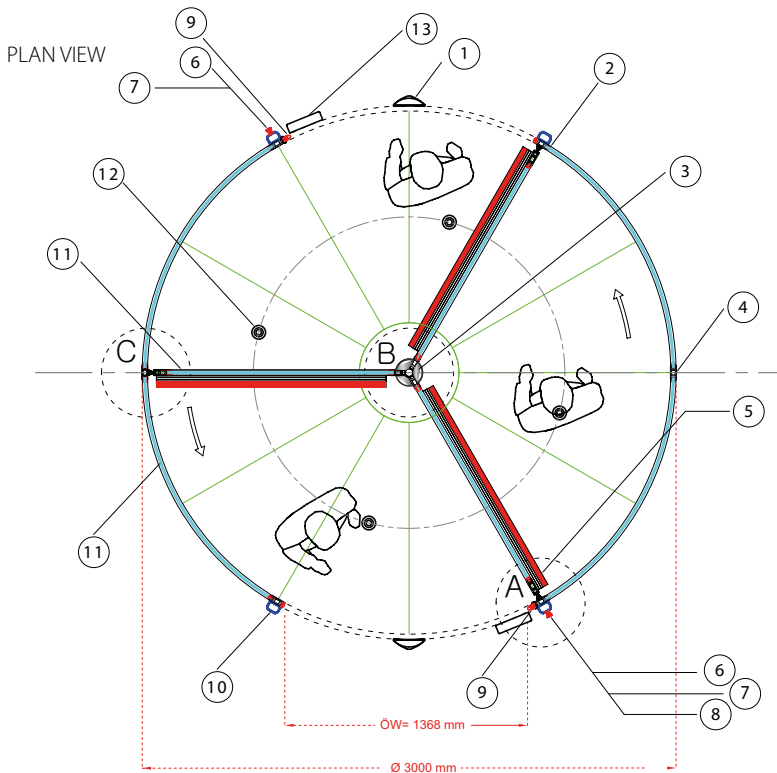

- 1 = Radar movement detector
 - 2 = Glass sealing
 - 3 = Central shaft
 - 4 = 80x30 mm aluminium profile
 - 5 = Heel protection
 - 6 = Emergency stop switch
 - 7 = Push pad
 - 8 = Control panel
 - 9 = Hand sensor
 - 10 = Post safety
 - 11 = 10 mm LSG
 - 12 = 10 W LED
 - 13 = Front post safety sensor
- ØW = Opening width

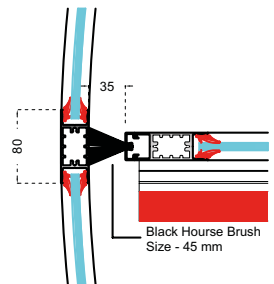

DETAIL C

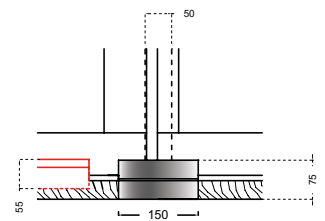

DETAIL D

Technical information automatic revolving door without central shaft

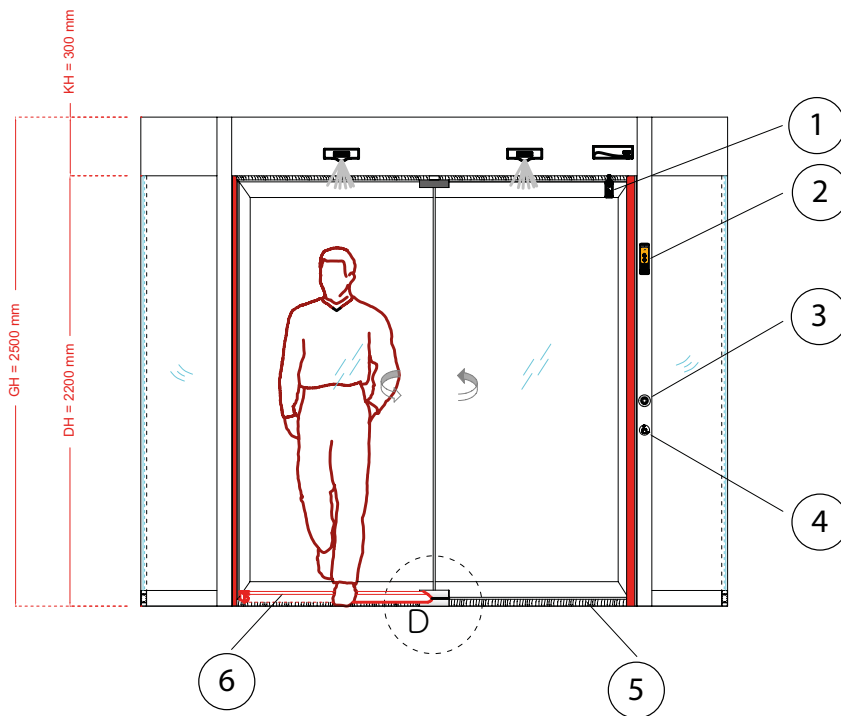

- 1 = Manual locking
- 2 = Control panel/programme switch
- 3 = Emergency stop switch
- 4 = Push pad
- 5 = Brush sealing
- 6 = Heel protection

GH = total height
 DH = Passage height
 KH = Canopy height

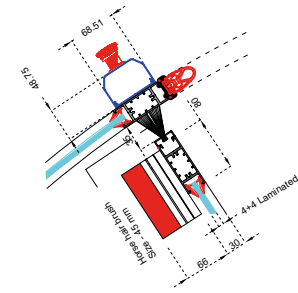

DETAIL A

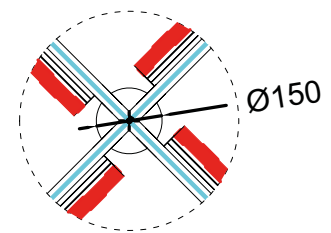

DETAIL B

PLAN VIEW

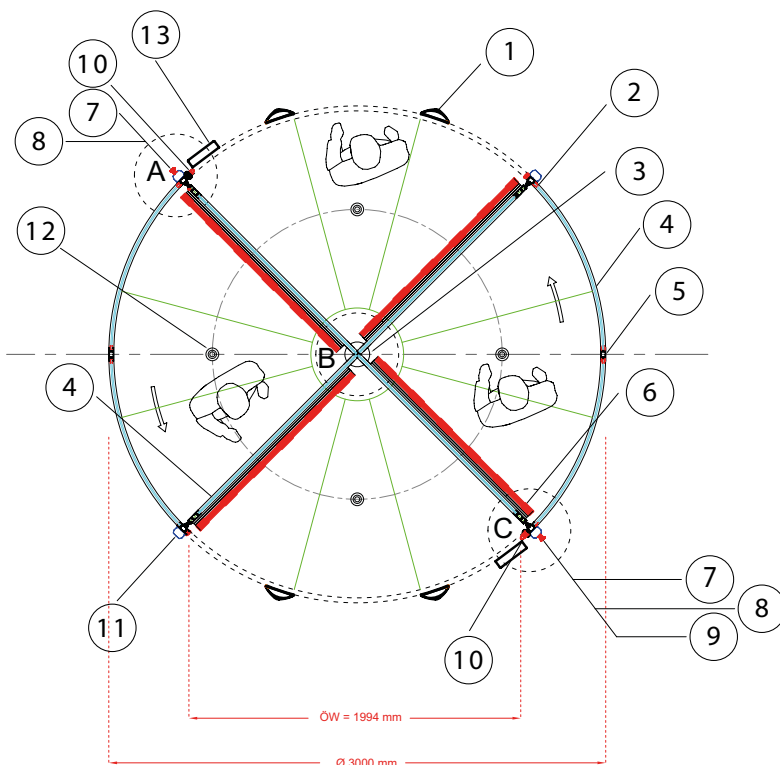

- 1 = Radar movement detector
- 2 = Glass sealing
- 3 = Central shaft
- 4 = 8 mm LSG
- 5 = 80x30 mm aluminium profile
- 6 = Heel protection
- 7 = Emergency stop switch
- 8 = Push pad
- 9 = Control panel
- 10 = Hand sensor
- 11 = Post safety
- 12 = 10 W LED
- 13 = Front post safety sensor
- ÖW = Opening width

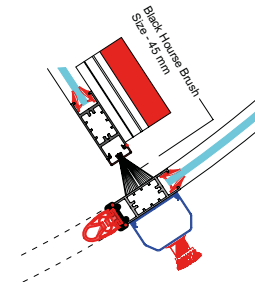

DETAIL C

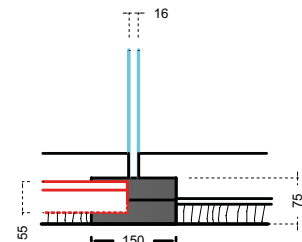

DETAIL D

GEZE TSA 355

Dimensions

3-leaf revolving doors										
Outer diameter	Inner diameter	Leaf width	Passage width	Segment area in m ²	Maximum number of people *	Capacity/minute **	Maximum number of people *	Capacity/minute **	Maximum number of people *	Capacity/minute **
1800	1740	840	760	0.80	1	8	1	8	1	6
2000	1940	940	860	1.00						
2200	2140	1040	960	1.25						
2400	2340	1140	1060	1.50	2	15	2	15		
2600	2540	1240	1160	1.75						
2800	2740	1340	1260	2.00						
3000	2940	1440	1360	2.35	4	30	3	23		
3200	3140	1540	1460	2.65						
3400	3340	1640	1560	3.00						
3600	3540	1740	1660	3.40	6	44	3	23		
3800	3740	1840	1760	3.75			4	30		

All dimensions in mm

* Specifies the number of people who can be in one segment during typical use.

** Specifies the maximum number of people that can pass in one direction per minute.

4-leaf revolving doors										
Outer diameter	Inner diameter	Leaf width	Passage width	Segment area in m ²	Maximum number of people *	Capacity/minute **	Maximum number of people *	Capacity/minute **	Maximum number of people *	Capacity/minute **
1800	1740	840	1140	0.65	1	10			1	10
2000	1940	940	1360	0.75						
2200	2140	1040	1500	0.95						
2400	2340	1140	1640	1.10	2	20				
2600	2540	1240	1780	1.30						
2800	2740	1340	1920	1.50	3	30	1	10		
3000	2940	1440	2060	1.75						
3200	3140	1540	2200	1.95						
3400	3340	1640	2340	2.25	4	40	2	20		
3600	3540	1740	2480	2.55						
3800	3740	1840	2620	2.80	5	50	3	30		

All dimensions in mm

* Specifies the number of people who can be in one segment during typical use.

** Specifies the maximum number of people that can pass in one direction per minute.

Different dimensions and equipment options available on request

Night-time closer

3-leaf

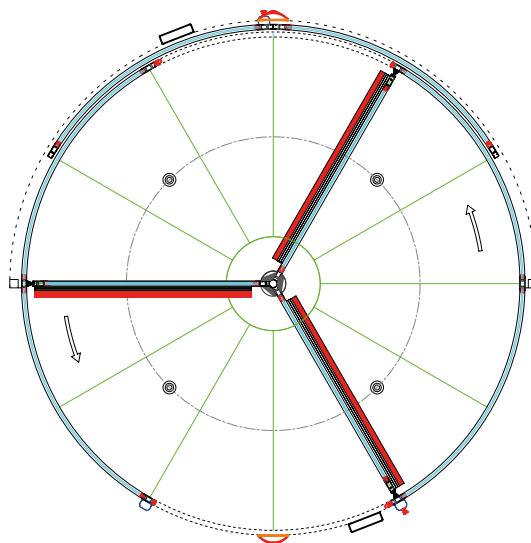
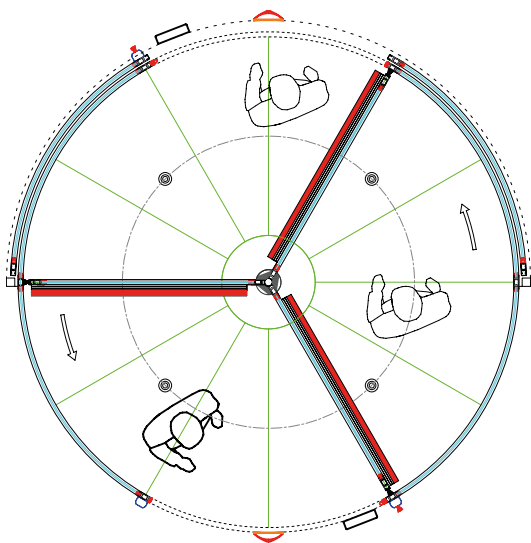

4-leaf

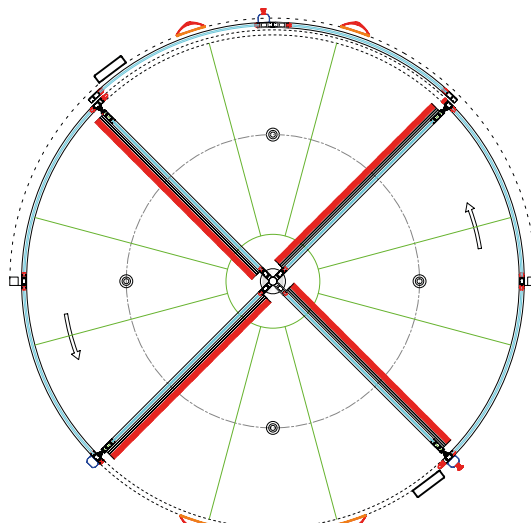
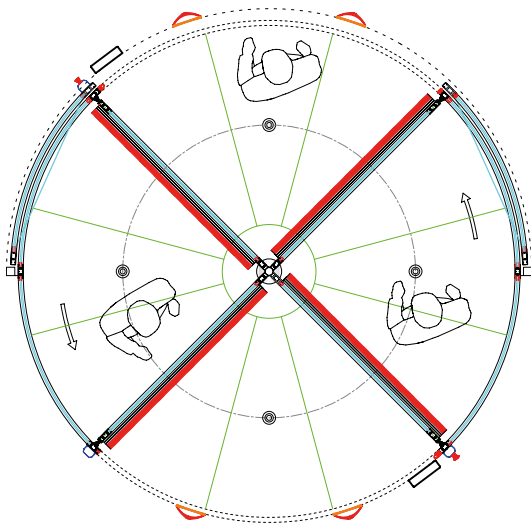

Variant with folding leaves (break-out)

3-leaf

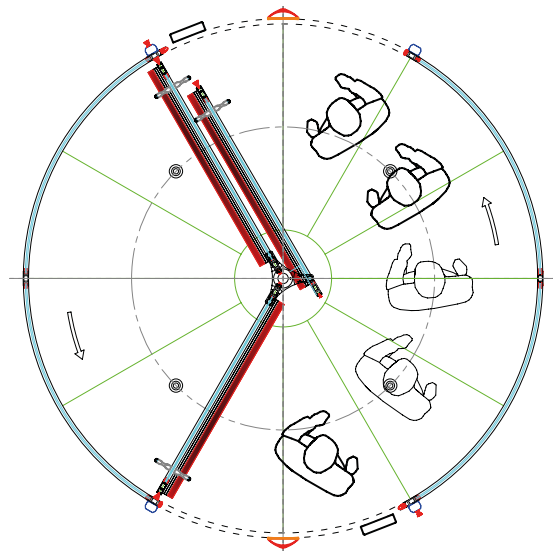
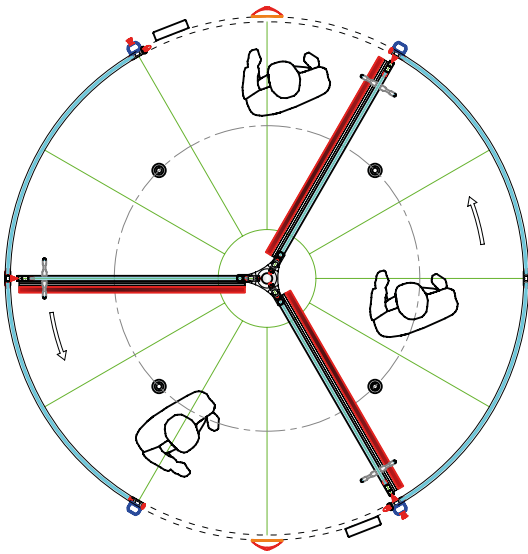

4-leaf

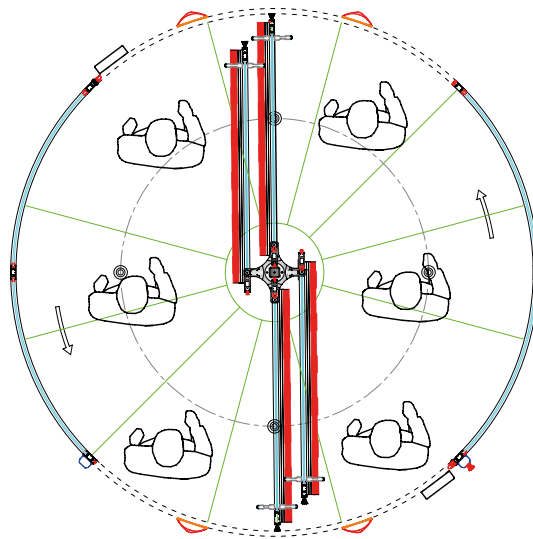
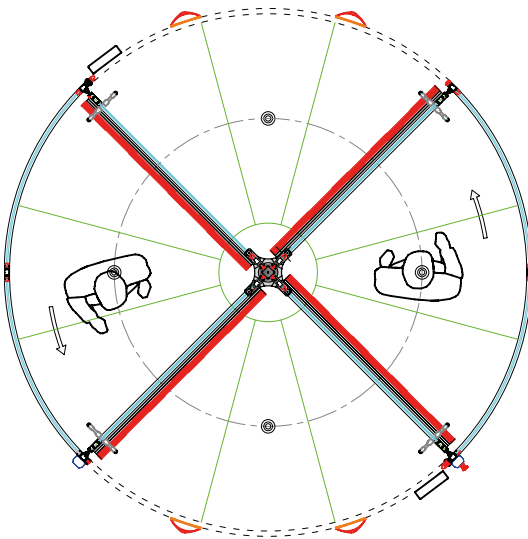

Hot-air curtains

3-leaf

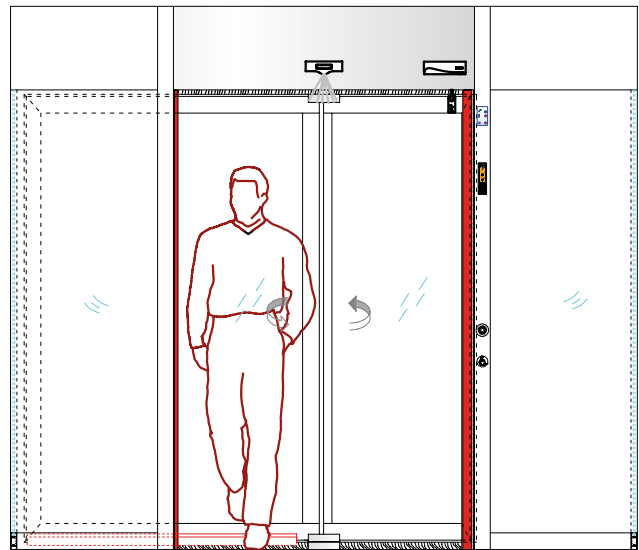
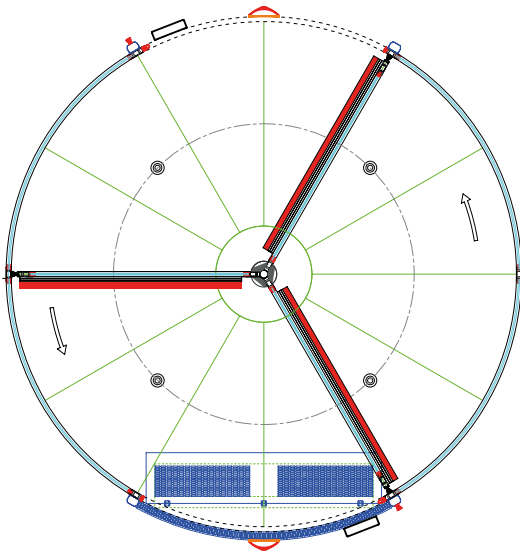

4-leaf

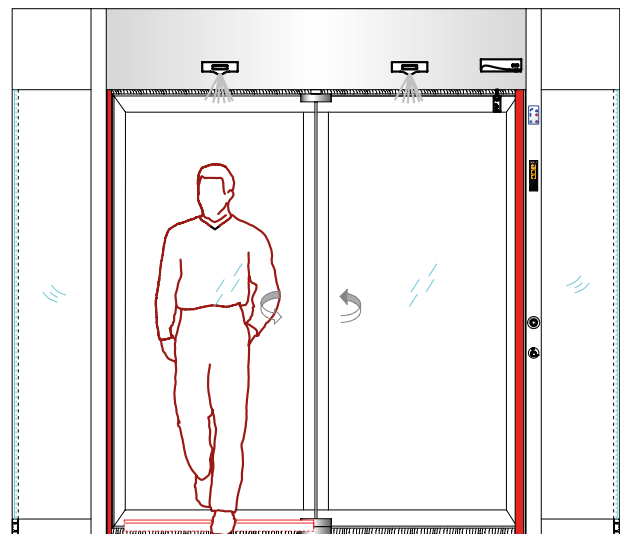
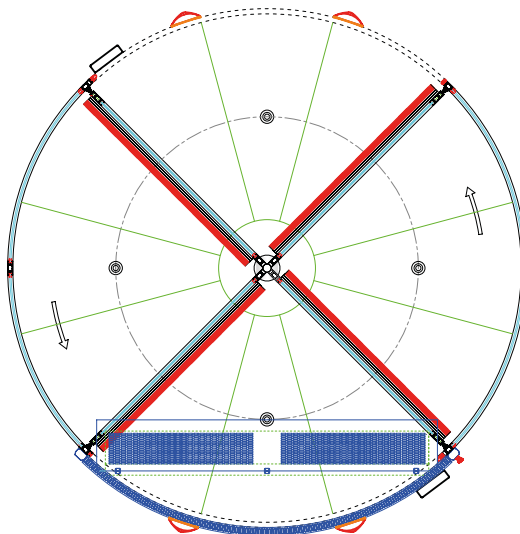

Differences between the temperature inside a building and the outside temperature cause unwanted air exchange in the door area. Air curtain systems are used to prevent this air exchange. They prevent the penetration of cold air even with revolving doors. As a result, the area directly by the door can be used economically.

GEZE TSA 395 revolving door drive

The drive for large doors

The TSA 395 model is the optimal choice for buildings with central access with high access frequency. The large door segments facilitate comfortable access to the building. This allows high visitor flows to be handled safely and representative façade entrances to be created. TSA 395 is available as a 3- or 4-leaf version up to a diameter of 6000 mm. A versatile selection is also available in the surface and colour design. A night-time closer can be selected as an additional option. Only an automatic variant is available due to the size of the door system. The central area of the door systems can optionally be equipped with a showcase for further individual design, for example for advertising purposes.

The door system has been tested and certified according to EN 16005.

Thanks to the optionally available folding leaves (break-out), revolving doors are also suitable for use in escape and rescue routes, depending on building regulations and the required width of the escape route.

This door variant is the optimal choice for projects with the following requirements:

- High person capacity
- High access convenience
- High degree of customisation in diameter, height, features and options
- Version with 3 or 4 leaves, with and without showcase

This model is particularly suitable for shopping centres, furniture stores or airports.



Galeri Resort, Antalya

Technical data

Standard features	
System	automatic
Emergency stop switch	one for each entrance and exit
Push pad	one for each entrance and exit
Post safety	standard for each entrance
Manual stop possible	
Passive seal to prevent hands from becoming trapped	standard for each entrance
Radar movement detector	one for each entrance and exit
Heel protection	at the bottom of the leaves
Presence detector	one for each entrance and exit
Curved glasses	8 mm LSG
Glass for leaves	8 mm LSG
Locking	manual locking
Roof	MDF cover for the interior aluminium sheet for the exterior area
Brushes	40 mm horse hair brushes
Ceiling	12 segments made of 1.5 mm thick aluminium sheet
Glass seal	EPDM
Canopy	aluminium and steel profiles
Colour	natural anodised or RAL colours
Illumination	4 x 8 W LED downlight
Control panel	control panel with position switch
Optional features	
Stainless steel cladding	•
Gold coloured stainless steel cladding	•
Bright stainless steel panel	•
Entrance mat	•
Door handle	•
Coloured glass	•
Heel protection for safety (below)	•
Passage height in various dimensions	•
Extra manual locking	•
Break-out leaves	•
Extra manual locking and switch	•
Waterproof roof for the exterior, with drain channel	•
4 LED lights 10 W extra	•
20x30x2 mm stainless steel floor ring	•
Hot-air curtain	•

Technical data



Standard

- On/off switch for lighting
- Modes for testing and error detection
- Setting speed control and waiting periods
- Setting for limiting the torque
- Setting for start and stop periods
- All revolving door settings can be made using this touch screen

Standard



Post safety



Front post safety sensor



Access for people with disabilities and for the elderly



Mobile safeguarding device



Push pad



Heel protection



Emergency stop switch

Technical data

FRONTAL VIEW

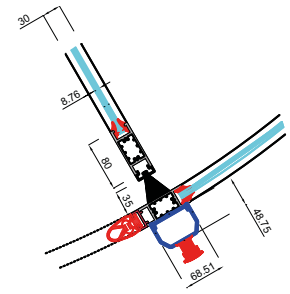
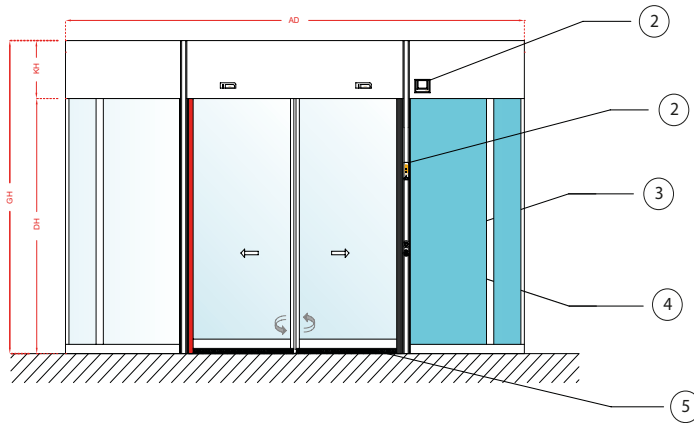

DETAIL A

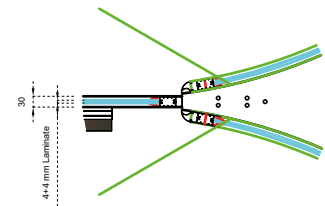

DETAIL B

- 1 = Manual locking
- 2 = Control panel/programme switch
- 3 = Emergency stop switch
- 4 = Push pad
- 5 = Brush sealing

- AD = Outer diameter
- GH = Total height
- DH = Passage height
- KH = Canopy height

PLAN VIEW

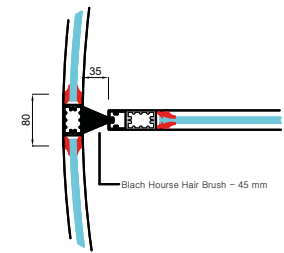
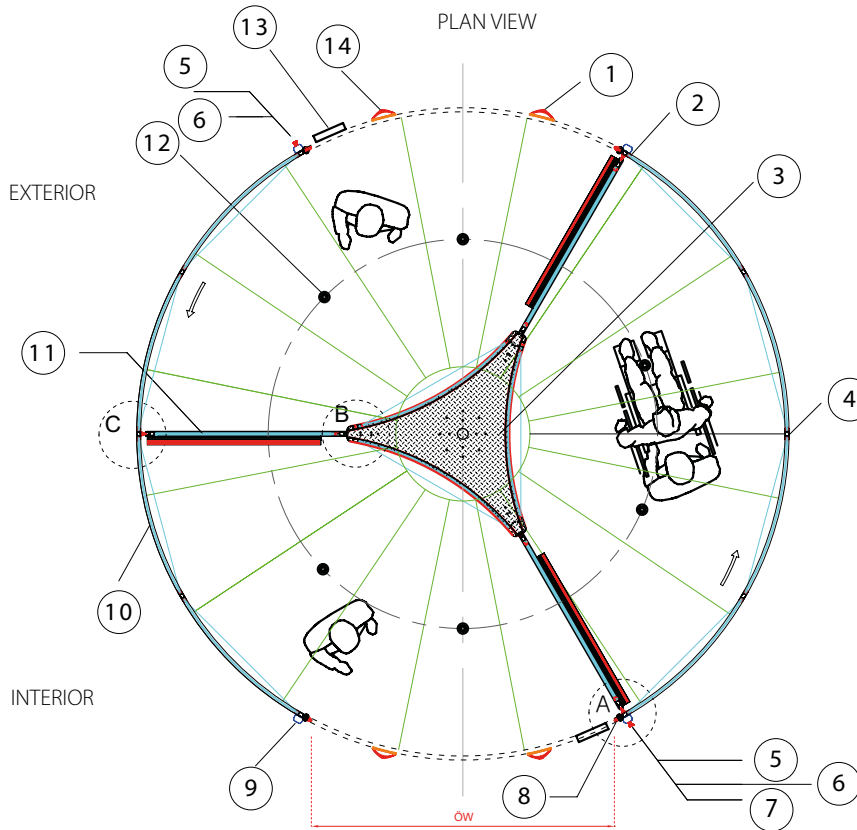

DETAIL C

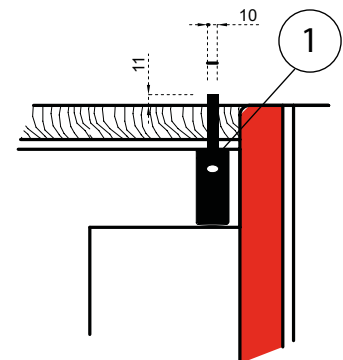

DETAIL D

- 1 = Manual locking

- 1 = Radar movement detector
- 2 = Glass sealing
- 3 = Integrated showcase
- 4 = 80x30 mm aluminium profile
- 5 = Emergency stop switch
- 6 = Push pad
- 7 = Control panel
- 8 = Post safety
- 9 = Attachment profile post
- 10 = 8 mm LSG
- 11 = 8 mm LSG
- 12 = 10 Watt LED
- 13 = Front post safety sensor
- 14 = Radar movement detector
- ÖW = Opening width

GEZE TSA 395

Dimensions

3-leaf revolving doors					Maximum number of people *	Capacity/minute **	Maximum number of people *	Capacity/minute **
Outer diameter	Inner diameter	Leaf width	Passage width	Segment area in m ²				
3-leaf with triangular showcase								
4000	3940	1270	1800	3.60	7	53	2	15
4500	4440	1520	2050	4.65	8	60	2	15
5000	4940	1770	2300	5.90	10	75	3	22
6000	5940	2270	2820	8.70	15	112	4	30
3-leaf without showcase								
4000	3940	1740	1800	4.05	9	68	2	15
4500	4440	1990	2050	5.15	10	75	2	15
5000	4940	2240	2300	6.35	14	105	3	22

All dimensions in mm

* Specifies the number of people who can be in one segment during typical use.

** Specifies the maximum number of people that can pass in one direction per minute.

4-leaf revolving doors					Maximum number of people *	Capacity/minute **	Maximum number of people *	Capacity/minute **
Outer diameter	Inner diameter	Leaf width	Passage width	Segment area in m ²				
4-leaf with square showcase								
4000	3940	1320	2700	2.45	6	60	1	10
4500	4440	1570	3000	3.30	8	82	2	20
5000	4940	1850	3400	4.20	11	110	2	20
6000	5940	2320	4170	6.30	14	140	3	30
4-leaf without showcase								
4000	3940	1740	2700	3.05	7	70	1	10
4500	4440	1990	3000	3.85	9	90	2	20
5000	4940	2240	3400	4.80	11	110	2	20

All dimensions in mm

* Specifies the number of people who can be in one segment during typical use.

** Specifies the maximum number of people that can pass in one direction per minute.

Different dimensions and equipment options available are available on request

GEZE TSA 395 Multi revolving door drive

The universal door drive

The TSA 395 Multi model is the optimal choice for buildings with central access with high access frequency. Due to the 2-leaf design in the door area, there are particularly large segments which allow for comfortable building access. As a result, this door variant can also be used with luggage or shopping trolleys as well as by wheelchair users with an accompanying person. As a revolving door with an integrated linear sliding door, this door system is very flexible. The sliding door function also allows for the comfortable transport of longer objects or the passage of larger groups of people in the shortest time possible. The model is available up to a diameter of 5400 mm and creates representative entrances.

A versatile selection is also available in the surface and colour design. The laterally integrated showcases can optimally be used for advertising purposes. At night, the showcases are placed in front of the entrance. The door is securely locked and the segments are closed.

This door variant is optimal in projects with the following requirements:

- High person capacity
- High access convenience
- Version with 2 door leaves and integrated sliding door

This model is therefore ideal for use in shopping centres, furniture stores and airports.



Forum Kayseri

GEZE TSA 395 MULTI

Technical data

Standard features	
System	automatic
Emergency stop switch	one for each entrance and exit
Push pad	one for each entrance and exit
Post safety	standard for each entrance
Passive seal to prevent hands from becoming trapped	standard for each entrance
Radar movement detector	one for each entrance and exit
Heel protection	at the bottom of the leaves
Presence detector	one for each entrance and exit
Curved glasses	8 mm LSG
Glass for leaves	8 mm LSG
Locking	automatic locking
Roof	MDF cover for the interior aluminium sheet for the exterior area
Brushes	70 mm horse hair brushes
Soffit	12 segments made of 1.5 mm thick aluminium sheet
Glass seal	EPDM
Canopy	aluminium and steel profiles
Colour	natural anodised or RAL colours
Illumination	8 x 10 W LED downlight
Control panel	control panel with position switch

Optional features	
Stainless steel cladding	•
Gold coloured stainless steel cladding	•
Bright stainless steel panel	•
Entrance mat	•
Door handle	•
Coloured glass	•
Heel protection for safety (below)	•
Passage height in various dimensions	•
Extra manual locking	•
Break-out leaves	•
Extra manual locking and switch	•
Engine block heater	•
Waterproof roof for the exterior, with drain channel	•
4 LED lights 10 W extra	•
20x30x2 mm stainless steel floor ring	•
Hot-air curtains	•

Technical data



Standard

- On/off switch for lighting
- Modes for testing and error detection
- Setting speed control and waiting periods
- Setting for limiting the torque
- Setting for start and stop periods
- All revolving door settings can be made using this touch screen

Standard



Post safety



Presence detector



Access for people with disabilities and for the elderly



Heel protection



Push pad



Emergency stop switch



Mobile safeguarding devices

GEZE TSA 395 MULTI

Technical data

FRONTAL VIEW

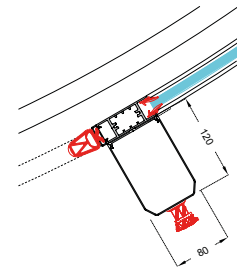
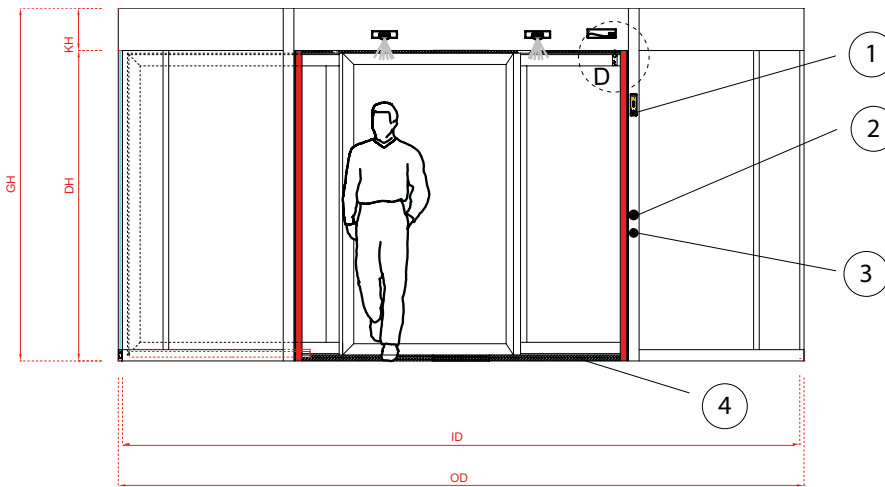

DETAIL A

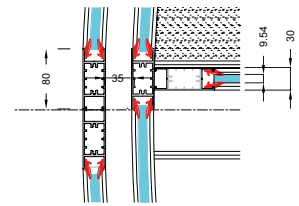

DETAIL B

- 1 = Control panel
- 2 = Emergency stop switch
- 3 = Push pad
- 4 = Brush sealing

- ID = Inner diameter
- AD = Outer diameter
- GH = Total height
- DH = Passage height
- KH = Canopy height

PLAN VIEW

EXTERIOR

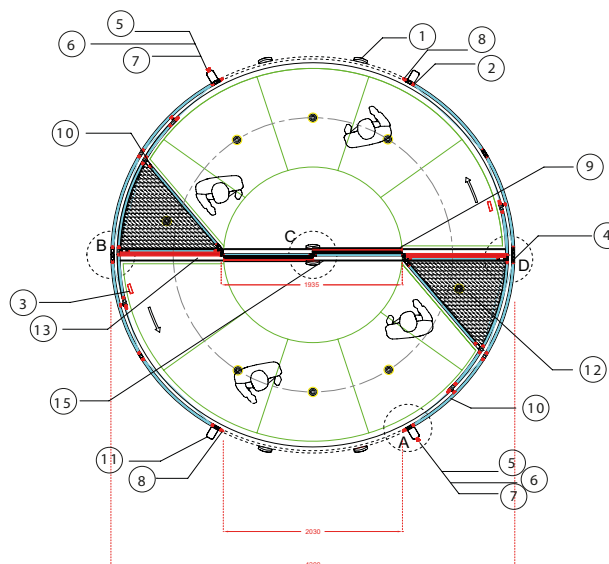

INTERIOR

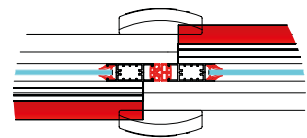

DETAIL C

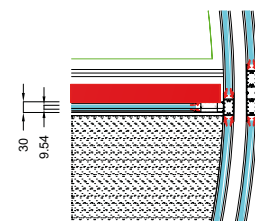

DETAIL D

- 1 = Radar movement detector
- 2 = Glass sealing
- 3 = Presence detector
- 4 = 80x30 mm aluminium profile
- 5 = Emergency stop switch
- 6 = Push pad
- 7 = Control panel
- 8 = Hand sensor
- 9 = Post safety
- 10 = 4 mm + 4 mm LSG
- 11 = Sensor cover
- 12 = 10 W LED
- 13 = Light curtain sensor
- 14 = Radar movement detector
- 15 = Sliding door
- ÖW = Opening width

Dimensions

Outer diameter	Inner diameter	Door system installation width	Passage width revolving door	Passage width sliding door	Maximum number of persons *	Capacity/minute **	Maximum number of persons *	Capacity/minute **
3600	3540	3840	1530	1650	5	75	2	8
4200	4140	4440	1780	1930	7	95	2	8
4500	4440	4740	1980	2040	8	100	3	10
4800	4740	5040	2030	2200	9	105	3	12
5400	5340	5640	2290	2480	11	115	3	12

All dimensions in mm

* Specifies the number of people who can be in one leaf during typical use.

** Specifies the maximum number of people that can pass in one direction per minute.

Automatic operation revolving door

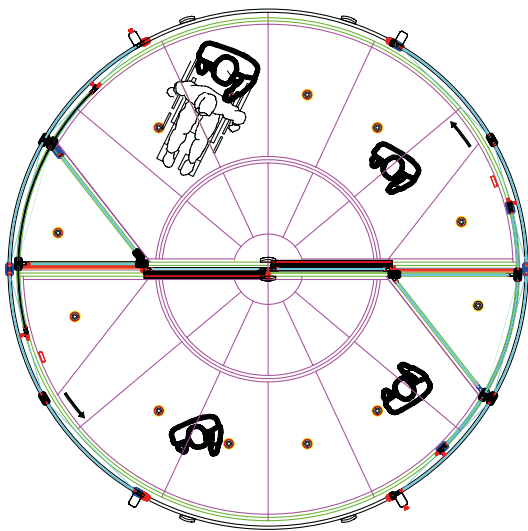

Position night/locked

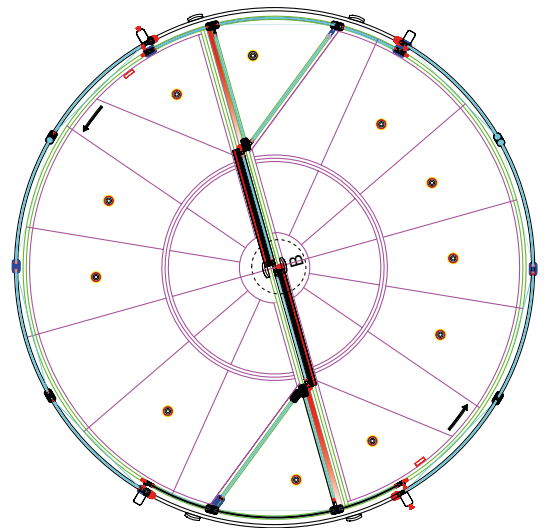

Position sliding door operation

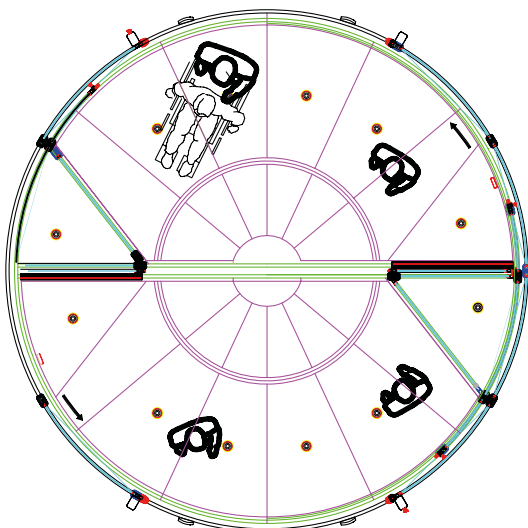



EC- Declaration of Conformity AB – Uygunluk Beyanı

The Manufacturer
(İmalatçı)

Geze Kapı ve Pencere Sistemleri San.Tic.ve Ltd.Şti
Nidakule Ataşehir Kuzey
Barbaros Mah., Begonya Sok.,
No: 3 Kat: 4, 34746 Ataşehir / İstanbul
Telefon: + 90 (0) 216 455 43 15 - Faks. + 90 (0) 216 455 82 15
www.geze.com.tr

Hereby declares the following product:
(Aşağıda belirtilen ürünler için geçerlidir.)

Product designation
(Ürün Tanımı)

Revolving door drive
(Dönerkapı)

Brand
(Marka)

GEZE

Type designation. Model
(Ürün Modeli)

TSA 355 / TSA 395

Complies with the provisions of the directive relating to electrical equipment designed for use within certain voltage limits (2006/95/EG) and the directive relating to electromagnetic compatibility (2004/108/EC)
(Belirli voltaj aralıklarında kullanılmak üzere üretilmiş elektrikli aletler (2006/95/EG) ve elektromanyetik uyumluluk ile ilgili (2004/108/EC) normlarının direktiflerine uygundur.)

The following standards have been applied,
(Tanımlanan ürünler aşağıdaki Avrupa normlarının talimatlarına uyumludur.)

EN 60335-1
EN 60335-2-103
EN 16005: 2012

EN 61000-6-2
EN 61000-6-3

The following party was responsible for the documentation: Cahit Oğul Teoman / SR Tel: +90 216 455 43 15
(Belgelemeden sorumlu yetkili personel:)

İstanbul, 01 Mart 2019

Deniz Ergener
General Manager (Genel Müdür)

References



University of Manchester, Great Britain



Conforium Hotel, Istanbul, Turkey

GEZE AUTOMATIC REVOLVING DOOR SYSTEMS



Shopping centre, Özdemir Park, Zonguldak, Turkey



Ankara Ticaret Merkezi office building, Ankara, Turkey

Door technology	
01	Overhead door closers
02	Hold-open systems
03	Integrated door closers
04	Floor springs and all-glass fittings
05	Sliding fitting systems and linear guides
Automatic door systems	
06	Swing doors
07	Sliding, telescopic and folding doors
08	Curved sliding doors
09	Revolving doors
10	Activation devices and sensors
Smoke and heat extraction and window technology	
11	Fanlight opening systems
12	Electric opening and locking systems
13	Electrical spindle and linear drives
14	Electric chain drives
15	Smoke and heat extraction systems
Safety technology	
16	Emergency exit systems
17	Access control systems
18	Panic locks
19	Electric strikes
20	Building management system
Glass systems	
21	Manual sliding wall systems (MSW)
22	Integrated all-glass systems (IGG)



POTENTIAL APPLICATIONS OF GEZE PRODUCTS



Door technology

The functionality, superior performance and reliability of GEZE door closers are impressive. A common design across the range, the ability to use them on all common door leaf widths and weights, and the fact that they can be individually adjusted makes their selection simple. They are continually being improved and enhanced with up-to-date features. For example, the requirements of fire protection and accessibility are fulfilled with a door closer system.

Automatic door systems

GEZE automatic door systems open up a huge variety of options in door design. The latest, innovative high-performance drive technology, safety, ease of accessibility and first class universal drive design set them apart. GEZE offers complete solutions for individual requirements.

Smoke and heat extraction and window technology

GEZE smoke and heat extraction systems and ventilation technology provide complete systems solutions combining the many requirements of different types of windows. We supply a full range from energy efficient drive systems to natural ventilation and complete solutions for supplying and extracting air, also as certified SHEVs.

Safety technology

GEZE safety technology sets the standards where preventative fire protection, access control and anti-theft security in emergency exits are concerned. For each of these objectives GEZE offers tailored solutions, which combine the individual safety requirements in one intelligent system and close doors and windows in case of danger in a coordinated manner.

Building systems

In GEZE's Building Management System GEZE door, window and safety products can be integrated in to the security and control systems of the building. A central control and visualisation system monitors various automation components in the building and offers security through many different networking capabilities.

Glass systems

GEZE glass systems stand for open and transparent interior design. They can either blend discreetly into the architecture of the building or stand out as an accentuated feature. GEZE offers a wide variety of technologies for functional, reliable and aesthetic sliding wall or sliding door systems providing security with lots of design scope.

GEZE GmbH
P.O. Box 1363
71226 Leonberg
Germany

GEZE GmbH
Reinhold-Vöster-Straße 21-29
71229 Leonberg
Germany
Tel. +49 7152 203 0
Fax +49 7152 203 310
www.geze.com

Germany
GEZE GmbH
Niederlassung Süd-West
Breitwiesenstraße 8
71229 Leonberg
Tel. +49 7152 203 594
Fax +49 7152 203 438
leonberg.de@geze.com

GEZE GmbH
Niederlassung Süd-Ost
Parkring 17
85748 Garching bei München
Tel. +49 7152 203 6440
Fax +49 7152 203 77050
muenchen.de@geze.com

GEZE GmbH
Niederlassung Ost
Albert-Einstein-Ring 5
14532 Kleinmachnow bei Berlin
Tel. +49 7152 203 6840
Fax +49 7152 203 76849
berlin.de@geze.com

GEZE GmbH
Niederlassung Mitte/Luxemburg
Siemensstraße 14
63263 Neu-Isenburg
Tel. +49 7152 203 6888
Fax +49 7152 203 6891
frankfurt.de@geze.com

GEZE GmbH
Niederlassung West
Heltorfer Straße 12
40472 Düsseldorf
Tel. +49 7152 203 6770
Fax +49 7152 203 76770
duesseldorf.de@geze.com

GEZE GmbH
Niederlassung Nord
Albert-Schweitzer-Ring 24-26 (3. OG)
22045 Hamburg
Tel. +49 7152 203 6600
Fax +49 7152 203 76608
hamburg.de@geze.com

GEZE Service GmbH
Niederlassung Süd-West
Reinhold-Vöster-Straße 25
71229 Leonberg
Tel. +49 1802 923392
Fax +49 7152 9233 359
service-leonberg.de@geze.com

GEZE Service GmbH
Niederlassung Süd
Parkring 17
85748 Garching bei München
Tel. +49 1802 923392
Fax +49 7152 9233 859
service-muenchen.de@geze.com

GEZE Service GmbH
Niederlassung Mitte/Luxemburg
Siemensstraße 14
63263 Neu-Isenburg
Tel. +49 1802 923392
Fax +49 7152 9233 659
service-frankfurt.de@geze.com

GEZE Service GmbH
Niederlassung West
Heltorfer Straße 12
40472 Düsseldorf
Tel. +49 1802 923392
Fax +49 7152 9233 559
service-duesseldorf.de@geze.com

GEZE Service GmbH
Niederlassung Ost
Albert-Einstein-Ring 5
14532 Kleinmachnow bei Berlin
Tel. +49 1802 923392
Fax +49 7152 9233 759
service-berlin.de@geze.com

GEZE Service GmbH
Niederlassung Nord
Albert-Schweitzer-Ring 24-26 (3. OG)
22045 Hamburg
Tel. +49 1802 923392
Fax +49 7152 9233 459
service-hamburg.de@geze.com

Austria
GEZE Austria
Wiener Bundesstrasse 85
A-5300 Hallwang
Tel: +43 6225 87180
Fax +43 6225 87180 299
austria.at@geze.com

**Baltic States –
Lithuania / Latvia / Estonia**
Tel. +371 678960 35
baltic-states@geze.com

Benelux
GEZE Benelux B.V.
Industrieterrein Kapelbeemd
Steenoven 36
5626 DK Eindhoven
Tel. +31 4026290 80
Fax +31 4026290 85
benelux.nl@geze.com

Bulgaria
GEZE Bulgaria - Trade
Representative Office
Nickolay Haitov 34 str., fl. 1
1172 Sofia
Tel. +359 247043 73
Fax +359 247062 62
office-bulgaria@geze.com

China
GEZE Industries (Tianjin) Co., Ltd.
Shuangchenzhong Road
Beichen Economic Development
Area (BEDA)
Tianjin 300400, P.R. China
Tel. +86 22 26973995
Fax +86 22 26972702
chinasales@geze.com.cn

GEZE Industries (Tianjin) Co., Ltd.
Branch Office Shanghai
Jia Little Exhibition Center
Room C 2-102
Shenzhuan Rd. 6000
201619 Shanghai, P.R. China
Tel. +86 21 52340960
Fax +86 21 64472007
chinasales@geze.com.cn

GEZE Industries (Tianjin) Co., Ltd.
Branch Office Guangzhou
Room 17 C 3
Everbright Bank Building, No.689
Tian He Bei Road
510630 Guangzhou, P.R. China
Tel. +86 20 38731842
Fax +86 20 38731834
chinasales@geze.com.cn

GEZE Industries (Tianjin) Co., Ltd
Branch Office Beijing
Room 04-05, 7th Floor
Red Sandalwood Plaza
No. 27 Jianguo Road
Chaoyang District
100024 Beijing, P.R.China
Tel. +86 10 85756009
Fax +86 10 85758079
chinasales@geze.com.cn

France
GEZE France S.A.R.L.
ZAC de l'Orme Rond
RN 19
77170 Servon
Tel. +33 1 606260 70
Fax +33 1 606260 71
france.fr@geze.com

Hungary
GEZE Hungary Kft.
Hungary-2051 Biatorbágy
Vendel Park
Huber u. 1.
Tel. +36 23532 735
Fax +36 23532 738
office-hungary@geze.com

Iberia
GEZE Iberia S.R.L.
C/ Andorra 24
08830 Sant Boi de Llobregat
(Barcelona)
Tel. +34 902194 036
Fax +34 902194 035
info.es@geze.com

India
GEZE India Private Ltd.
MF 2 & 3, Guindy Industrial Estate
Ekkattuthangal
Chennai 600 097
Tamilnadu
Tel. +91 44 406169 00
Fax +91 44 406169 01
office-india@geze.com

Italy
GEZE Italia S.r.l
Sede di Vimercate
Via Fiorbellina 20
20871 Vimercate (MB)
Tel. +39 0399530401
Fax +39 039 9530459/419
italia.it@geze.com

Sede di Roma
Via Lucrezia Romana, 91
00178 Roma
Tel. +39 039 9530401
Fax +39 039 9530449
italia.it@geze.com

Korea
GEZE Korea Ltd.
T4-716 Western Tower, 24 Jeong-
balsanro, Ilsangu Goyangsi,
Gyeonggido, 10403, South Korea
Tel. +82 31 814 6410
Fax +82 31 814 6410
info.kr@geze.com

Poland
GEZE Polska Sp. z o.o.
ul. Marywilska 24
03-228 Warszawa
Tel. +48 224 404 440
Fax +48 224 404 400
geze.pl@geze.com

Romania
GEZE Romania S.R.L.
IRIDE Business Park,
Str. Dimitrie Pompeiu nr. 9-9a,
Building 10, Level 2, Sector 2,
020335 Bucharest
Tel. +40 212507 750
Fax +40 316201 258
office-romania@geze.com

Russia
OOO GEZE RUS
Letnikovskaya str. 10/2
Floor 6, room VII
115114 Moscow
Tel. +7 495 741 40 61
office-russia@geze.com

Scandinavia – Sweden
GEZE Scandinavia AB
Mallslingan 10
Box 7060
18711 Täby, Sweden
Tel. +46 87323 400
Fax +46 87323 499
sverige.se@geze.com

Scandinavia – Norway
GEZE Scandinavia AB avd. Norge
Industriveien 34 B
2073 Dal
Tel. +47 63957 200
Fax +47 63957 173
norge.se@geze.com

Scandinavia – Denmark
GEZE Danmark
Branch office of GEZE Scandinavia AB
Mårkærvej 13 L
2630 Taastrup
Tel. +45 463233 24
danmark.se@geze.com

Singapore
GEZE (Asia Pacific) Pte. Ltd.
21 Bukit Batok Crescent
#23-75 Wcega Tower
Singapore 658065
Tel. +65 6846 1338
Fax +65 6846 9353
gezesea@geze.com.sg

South Africa
Geze South Africa (Pty) Ltd.
GEZE, Building 3, 1019 Morkels Close
Midrand 1685
Tel. +87 94337 88
Fax +86 66137 52
info@gezesa.co.za

Switzerland
GEZE Schweiz AG
Zelglimatte 1A
6260 Reiden
Tel. +41 62 28554 00
Fax +41 62 28554 01
schweiz.ch@geze.com

Turkey
GEZE Kapı ve Pencere Sistemleri
San. ve Tic. Ltd. Sti.
İstanbul Anadolu Yakası Organize
Sanayi Bölgesi
Gazi Bulvarı Caddesi 8.Sokak No:8
Tuzla-İstanbul
Tel. +90 216 45543 15
Fax +90 216 45582 15
office-turkey@geze.com

Ukraine
GEZE Ukraine LLC
45, Elektrotekhnicheskaya str.,
Kiev, 02222
Tel./Fax +38 445012225
office-ukraine@geze.com

United Arab Emirates/GCC
GEZE Middle East
P.O. Box 17903
Jebel Ali Free Zone
Dubai
Tel. +971 48833 112
Fax +971 48833 240
gezeme@geze.com

United Kingdom
GEZE UK Ltd.
Blenheim Way
Fradley Park
Lichfield
Staffordshire WS13 8SY
Tel. +44 15434430 00
Fax +44 15434430 01
info.uk@geze.com

GEZE REPRESENTATIVE