

Automatic sliding doors

DCU1-NT

DCU1-2M-NT

DCU1

DCU1-2M

Original operating instructions

EN User manual

135503-09

GEZE

Contents

1	Introduction.....	3
1.1	Symbols and illustrations	3
1.2	Product liability	3
1.3	Special cases.....	3
1.4	More detailed information.....	4
1.5	Terms.....	4
2	Fundamental safety precautions	5
2.1	For the user.....	5
2.2	Intended use.....	5
3	Description.....	7
3.1	Set-up.....	7
3.2	Overview of the modes of operation.....	8
3.3	Operating elements.....	10
3.4	Door in normal operation	11
4	Operation	13
4.1	Selecting the mode of operation	13
4.2	Blocking and releasing modes of operation	14
4.3	Locking/unlocking (optional)	15
4.4	Behaviour in an emergency.....	15
4.5	Behaviour at fire alarm (Slimdrive SL-T30).....	16
4.6	Behaviour at smoke alarm (Slimdrive SL-RD)	16
4.7	Interlocking door system function	16
5	No mains voltage.....	17
5.1	Door behaviour in case of power failure	17
5.2	Locking/unlocking if there is no mains voltage.....	18
6	Fault messages	20
6.1	Keypad programme switch TPS/Display programme switch DPS.....	20
6.2	Mechanical programme switch MPS/MPS-ST.....	20
7	What to do if...?	20
8	Cleaning and maintenance	22
8.1	Cleaning	22
8.2	Maintenance.....	22
8.3	Rechargeable battery	23
9	Safety-related inspection by trained professionals.....	23
10	Technical data	23



1 Introduction

1.1 Symbols and illustrations

Warning notices







Warning notices are used in these instructions to warn you of personal injury and property damage.

- ▶ Always read and observe these warning notices.
- ▶ Observe all the measures that are marked with the warning symbol and warning word .

Warning symbol	Warning word	Meaning
	WARNING	Danger to persons. Non-compliance may result in death or serious injuries.
	CAUTION	Danger to persons. Non-compliance can result in minor to medium injuries.

Further symbols and illustrations

Important information and technical notes are highlighted to explain correct operation.

Symbol	Meaning
	means "important note"; information about avoiding property damage
	means "additional Information" The user's attention should be drawn to important addition information. There is no danger to persons or property, but it is particularly useful to read the additional information carefully.
	Symbol for an action: This means you have to do something. ▶ If there are several actions to be taken, keep to the given order.
	Escape and rescue route; means the sliding door cannot be operated in escape and rescue routes
	Not an escape and rescue route; means the sliding door cannot be operated in escape and rescue routes
	Break-out; means that the door leaves and side panels are equipped with a break-out function
	No break-out; means the function is not possible for break-out doors

1.2 Product liability

In accordance with the manufacturer's liability for their products as defined in the German "Produkthaftungsgesetz" (Product Liability Act), the information contained in this user manual (product information and proper use, misuse, product performance, product maintenance, obligations to provide information and instructions) is to be noted and followed. Failure to comply releases the manufacturer from his statutory liability.

1.3 Special cases

In certain cases, deviations from the information given in this user manual may occur. Examples:

- Special wiring
- Special function settings (parameters)
- Special software
- ▶ Please contact the service technician responsible for further information.

1.4 More detailed information

Information for commissioning and maintenance can be found in the wiring diagram and in the installation instructions for the various automatic sliding doors.

1.5 Terms

Term	Explanation
Activation device inside (KI)	Push button, switch or movement detector for activating the door drive. The activation device is located within the room enclosed by the door. Activation function in the "Automatic" and "Exit only" modes of operation. The activation device does not have any function in the "Night/Locked" and "Off" mode of operation.
Activation device outside (KA)	Push button, switch or movement detector for activating the door drive. The activation device is located outside the room enclosed by the door. Activation function in the "Automatic" mode of operation. The activation device does not have any function in the "Exit only", "Night/Locked" and "Off" mode of operation.
Activation device authorised (KB)	Access control function (for example key switch or card reader) used by authorised persons to activate the door drive. The activation function is active in the "Automatic" "Exit only", "Night/Locked" and "Off" modes of operation.
Opening safety sensor (SIO)	Presence detector (e.g. active infrared light sensor) for protecting the swinging range of the door in the opening direction. The sensor secures the secondary closing edge.
Closing safety sensor (SIS)	Presence detector (e.g. active infrared light sensor) for protecting the swinging range of the door in the closing direction. The sensor secures the main closing edge on the inside and outside.
Emergency stop	Self-locking switch with which immediate stopping of the door drive can be triggered in case of danger. The door drive remains in its current position until the user releases the emergency stop switch again, thus terminating the emergency stop situation.
Emergency lock	When the emergency lock is triggered, the door is closed and locked. The activations and safety devices are deactivated during the closing process.
Reset	Push button for restarting the drive after the operating voltage has been switched on or after a fire alarm has been terminated. When the push button is pressed, the self-retention integrated in the drive is activated, causing the drive to be activated.

2 Fundamental safety precautions

2.1 For the user

Carefully read and abide by this user manual before commissioning the door. Always observe the following safety instructions:

- Operating, maintenance and repair conditions specified by GEZE must be observed.
- The commissioning, mandatory installation, maintenance and repair work must be performed by experts authorised by GEZE.
- Any relevant additional country-specific and European directives must also be observed.
- Use in dry rooms only.
- The intervals for safety-related testing are to be complied with based on the country-specific regulations.
- The connection to the mains voltage must be made by a professional electrician.
- No changes may be made to the system without prior agreement from GEZE.
- GEZE shall assume no liability for damage caused by unauthorised changes to the system.
- The owner is responsible for safe operation of the system.
- Have a service technician check the safe operation of the system at regular intervals.
- Should safety devices be misaligned, thus preventing them from fulfilling their intended purpose, further operation is not permissible. The service technician must be informed without delay.
- Make sure that the safety stickers are attached visibly to any glass leaves and are in a legible state.
- Protect the programme switch against unauthorised access.
- Danger of injury by sharp edges on the drive when removing the cover
- Danger of injury by parts hanging down
- This appliance can be used by children aged from 8 years and above and persons with reduced physical, sensory or mental capabilities or lack of experience and knowledge if they have been given supervision or instruction concerning use of the appliance in a safe way and understand the hazards involved.
- Children shall not play with the appliance.
- Cleaning and user maintenance shall not be made by children without supervision.

2.2 Intended use

2.2.1 Automatic door systems

- The sliding door system is used for the automatic opening and closing of a building passage.
- The sliding door system may only be used in a vertical installation position and in dry rooms within the permitted application area.
- The sliding door system is designed for pedestrian traffic in buildings.
- The sliding door system is not designed for the following uses:
 - for industrial use
 - for areas of application which do not serve pedestrian traffic (such as garage doors)
 - on mobile objects such as ships
- The sliding door system may only be used:
 - in the modes of operation provided for by GEZE
 - with the components approved / released by GEZE
 - with the software delivered by GEZE
 - in the installation variants / types of installation documented by GEZE
 - within the tested/approved area of application (climate / temperature / IP rating)
- Any other use is considered non-intended and will lead to the exclusion of all liability and warranty claims to GEZE.
- The automatic sliding door system Slimdrive SL-T30 is intended for use in fire protection doors.
- The automatic sliding door system Slimdrive SL-RD is intended for use at smoke protection doors.
- The automatic sliding door systems Slimdrive SL RC2 and Slimdrive SC RC2 are intended for use as burglary-resistant sliding doors with Resistance class 2.
- Only automatic FR and BO (Break-Out) sliding door systems are intended for use in escape and rescue routes.

Important information about doors in escape and rescue routes (FR drives, break-out drives)

- Do not place objects in the passage area.
- Existing protective door leaves/safety leaves on sliding doors must be closed again after cleaning.
- The programme switch for changing the mode of operation on automatic door drives must be secured against activation by unauthorised persons.
- When using a key operated programme switch, the key must be removed after changing the mode of operation.
- The door may only be locked by authorised persons.

2.2.2 FR drives

The automatic FR sliding doors are equipped with components which allow them to be used as escape and rescue doors.

Redundant drive design (2 motors)

If the power supply fails (e.g. power failure), the sliding doors are opened with a battery (not in the "Night/Locked" mode of operation).

Switching over to safe mode

If a fault which could impede the automatic opening of the sliding door is detected in the drive, the door leaves are opened.

Deactivation of the escape and rescue route function

- By switching to the "Night/Locked" mode of operation, the sliding door is no longer available as an escape and rescue route.
- The "Night/Locked" mode of operation is not a defined mode of operation according to the guidelines on automatic sliding doors in escape and rescue routes (AutSchR).
- Only authorised persons may change the mode of operation with the key push button at the programme switch following authorisation (for example via the key switch).
- Switching to "Night/Locked" may only occur if the emergency exit route is no longer used, i.e. people are no longer in the building or an escape and rescue chart indicates other emergency exit routes for this time period.

Reduced opening width

To teach-in a reduced opening size, the operator must submit the escape route width specified for the escape route in writing. Only when this document has been submitted is it permitted to teach-in a reduced opening width. The set reduced opening width must be at least as large as the required escape path width. A copy of the document must be included with the service or test log. The reduced opening width may not be less than 30 % of the full opening width. The control cannot learn a smaller reduced position.

Product version FR-DUO

Two emergency exit directions possible.

Product version FR-LL

The door is locked in the "Shop closing time" mode of operation so that opening from the outside is prevented.

Product version FR-RWS (RWS = emergency exit system)

Additional mode of operation – similar to "Night/Locked", but with a lock that ensures a fail-safe escape route function. Opening is enabled by means of a required emergency stop switch.

2.2.3 Break-out drives

The door leaves and side panels can be broken out in the "Automatic", "Hold open" and "Shop closing time" modes of operation in the direction of emergency exit.

2.2.4 RC2 drives



The burglar-resistant function RC2 is only enabled in the "Night/Locked" mode of operation. When the door is operated in "Night/Locked" mode of operation, the rescue route function is deactivated.

3 Description

3.1 Set-up

i The door system shown is only a schematic diagram.
For technical reasons, we cannot show all of the possibilities here.
The operating elements can be arranged individually.

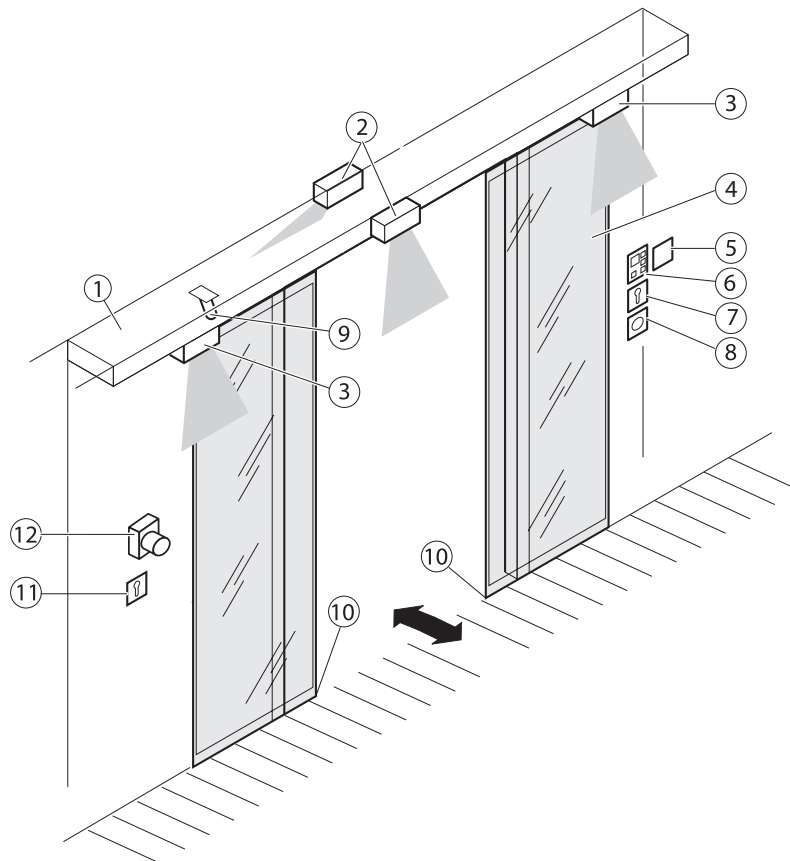

- 1 Drive
- 2 Combined detectors
- 3 Opening safety sensor (optional)
- 4 Door leaf
- 5 Pharmacist button (optional)
- 6 Programme switch
- 7 Key switch (optional) for enabling the programme switch
- 8 Emergency shut-off switch (optional)
- 9 Locking with locking bolt (optional)
- 10 Floor guide
- 11 Authorised activation device (KB) for authorised opening (e.g. key switch)
- 12 Emergency control (emergency shut off switch option, emergency stop switch option)

3.2 Overview of the modes of operation

The following modes of operation can be set on the automatic sliding doors:

- Automatic
- Exit only
- Hold open
- Night/Locked
- Off

3.2.1 Settings on the display programme switch (DPS)

Mode of operation	Key	Display				Explanation
		DE	EN	FR	IT	
Automatic		<i>RU</i>	<i>RU</i>	<i>RU</i>	<i>RU</i>	Door opens and closes again. Inside and outside activation devices active.
▫ Full opening width	+					Door opens the complete opening width. LED is off.
▫ Reduced opening width *	+					Door opens only part of the possible opening width (can be set). LED lights up.
Exit only (one-way operation)		<i>LS</i>	<i>EO</i>	<i>SU</i>	<i>SU</i>	Activation device internal active. Outer activation device only active as long as door is not closed. Door only opens for passage from the inside to the outside. The full/reduced opening width can be set as described under the "Automatic" mode of operation.
Hold open (not for SL RD)		<i>do</i>	<i>H</i>	<i>OP</i>	<i>PR</i>	Door remains open. The full/reduced opening width can be set as described under the "Automatic" mode of operation.
Night/Locked (For FR-RWS, see special function below)		<i>n0</i>	<i>no</i>	<i>ni</i>	<i>n-</i>	Displayed until door is closed and locked (if lock is present). <i>nR</i> <i>ni</i> <i>no</i> <i>ni</i> Door is closed and locked (if lock is present). Only "authorised" activation device is active.
Off (service/cleaning position)		<i>OF</i>	<i>OF</i>	<i>OF</i>	<i>OF</i>	The drive is switched off for maintenance purposes. FR door moves to the open position. The door leaves can be moved freely by hand. Activation and safety sensors are without function. Drive motor and locking are switched off.































* Observe notes in Chapter 2.2.2

Special functions for FR-RWS

Mode of operation	Key	Display				Explanation
		DE	EN	FR	IT	
RWS		<i>nr</i>	<i>nr</i>	<i>nr</i>	<i>nr</i>	The door is locked by the motor brake. Opening is enabled by means of the emergency stop switch.
Night/Locked	2 x	<i>n0</i>	<i>no</i>	<i>ni</i>	<i>n-</i>	Displayed until door is closed and locked (if lock is present). <i>nR</i> <i>ni</i> <i>no</i> <i>ni</i> Door is closed and locked (if lock is present). Opening is enabled by means of the emergency stop switch.

3.2.2 Settings on keypad programme switch (TPS)









Mode of operation	Key	Display	Explanation
Automatic	or		Door opens and closes again. Inside and outside activation devices active.
▫ Full opening width	+		Door opens the complete opening width.

Mode of operation	Key	Display	Explanation
▫ Reduced opening width *	 + 	  / 	Door opens only part of the possible opening width (can be set).
Exit only (one-way operation)	 or 	 ○  ○  ●  ○  ○	Activation device internal active. Outer activation device only active as long as door is not closed. Door only opens for passage from the inside to the outside. The full/reduced opening width can be set as described under the "Automatic" mode of operation.
Hold open (not for SL-RD)	 or 	 ○  ○  ○  ○  ●	Door remains open. The full/reduced opening width can be set as described under the "Automatic" mode of operation.
Night/Locked	 or 	 ○  ●  ○  ○  ○	Door is closed and locked (if lock is present). Movement detector not active. Only "authorised" activation device is active.
Off (service/cleaning position)		 ●  ○  ○  ○  ○	The drive is switched off for maintenance purposes. FR door moves to the open position. The door leaves can be moved freely by hand. Activation and safety sensors are without function. Drive motor and locking are switched off.

* Observe notes in Chapter 2.2.2

3.2.3 Settings on the mechanical programme switch MPS/MPS-ST

 Not for emergency exit system.

Mode of operation	Setting	Explanation
Automatic		Door opens and closes again. Inside and outside activation devices active.
▫ Full opening width	 	Door opens the complete opening width.
▫ Reduced opening width *	 	Door opens only part of the possible opening width (can be set).
Exit only (one-way operation)		Activation device internal active. Outer activation device only active as long as door is not closed. Door only opens for passage from the inside to the outside. The full/reduced opening width can be set as described under the "Automatic" mode of operation.
Hold open		Door remains open.
Night/Locked		Door is closed and locked (if lock is present). Movement detector not active. Only "authorised" activation device is active.
Off (service/cleaning position)		The drive is switched off for maintenance purposes. The door leaves can be moved freely by hand. Activation and safety sensors are without function. Drive motor and locking are switched off. FR door moves to the open position.

* Observe notes in Chapter 2.2.2

3.3 Operating elements

The modes of operation can be set using the following operating elements:

- Display programme switch DPS (see Chapter 3.3.1)
- Keypad programme switch TPS (see Chapter 3.3.2)
- Mechanical programme switch MPS with/without integrated key switch (optional) (see Chapter 3.3.3)

3.3.1 Display programme switch (DPS)

The modes of operation can be set at the display programme switch by pressing the respective keys.

Operation by unauthorised persons can be blocked as follows:

- Connection of an additional key switch
- or
- Assignment of a password, which the service technician sets with the ST220 in the service menu

If a dot appears on the bottom right-hand part of the display, maintenance is due.



If a dot appears on the left part of the display, the leaf position is unknown.



This can be the case, for example, during teach-in, before the drive has determined the position of the leaves via the teaching run.

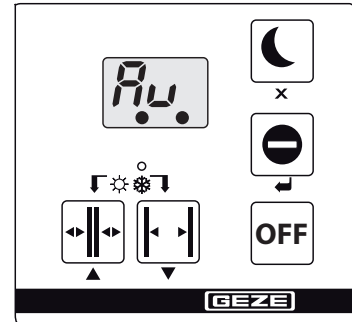

3.3.2 Keypad programme switch TPS

The system mode of operation is selected and the corresponding programme is displayed at the keypad programme switch.

Operation by unauthorised persons can be blocked as follows:

- Connection of an additional key switch
- or
- Assignment of a password, which the service technician sets with the ST220 in the service menu

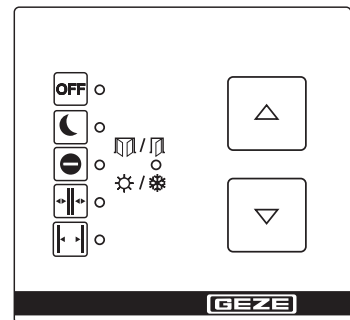

3.3.3 Mechanical programme switch MPS/MPS-ST

At the mechanical programme switch MPS, the mode of operation for the system is selected and the corresponding programme is displayed. The mechanical programme switch is accessible for everyone without a key switch.

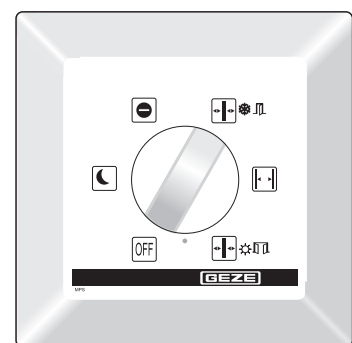

Mechanical programme switch MPS

With the mechanical programme switch MPS-ST, selection of the modes of operation is disabled if the key provided has been removed.

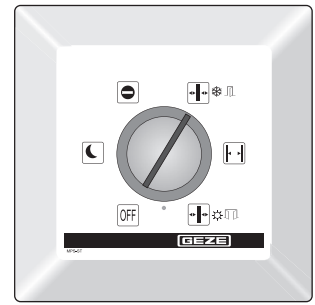





Mechanical programme switch MPS-ST with integrated key switch

3.4 Door in normal operation

i GEZE sliding doors can be operated with special control elements, which can induce deviating behaviour. Ask the service technician responsible for information on any special control elements which may be installed.

3.4.1 Standard functions (automatic mode of operation)

In normal operation, the door is automatically opened and closed.

What happens?	What does the door do?
An activation device (push button, switch or movement detector) is triggered.	Door opens and closes again.
Closing safety sensor is triggered when the door is open.	Door remains open.
Closing safety sensor is triggered when the door is closed.	Door remains closed.
Closing safety sensor is triggered while the door is closing.	Door opens again.
Opening safety sensor is triggered when the door is closed.	Door remains closed.
 Opening safety sensor is triggered while door is opening.	Door stops.
 Opening safety sensor is triggered while door is opening.	The door does not stop until the reduced opening width (escape route width) has been reached.
A person moves toward the opened door and a movement detector is activated.	Door remains open.
A person moves toward the closing door and a movement detector is activated.	Door opens again.
Door contacts an obstruction when opening.	Door stops, waits and attempts to move to the open position at a reduced speed three times. Then the door closes again.
Door contacts an obstruction when closing.	Door reopens immediately, waits the hold-open time and then closes at a reduced speed.
 Door leaf or side panel is broken out.	Door remains in the current position and can be moved manually.
 Door leaf or side panel is latched in again.	Door functions again in the last mode of operation.

3.4.2 Special functions

The special functions of the door system are triggered using special switches.

Switches / push buttons	Standard	FR	SL-RD	SL T30	SL RC2	BO	What does the switch / push button do?
Activation device "authorised" Emergency shut-off switch	×	×	-	-	×	×	Door opens once and closes after the hold-open time. The set mode of operation is retained. If there is a lock, the door is relocked in the "Night/Locked" mode of operation
	-	-	×	-	-	-	Door opens once and immediately closes again
	-	-	-	×	*	-	Door opens once and immediately closes again
Key switches of the programme switch	×	×	×	×	×	×	If a key switch is connected to the programme switch, the operation of the programme switch can be locked or released with it
Emergency stop switch (currentless)	×	-	-	-	×	×	Door opens and performs the function selected for battery operation: <ul style="list-style-type: none"> ▫ Open and switch off ▫ Close and switch off ▫ Normal operation for maximum 30 minutes or 30 open/close cycles, then open and switch off ▫ Normal operation for maximum 30 minutes or 30 open/close cycles, then close and switch off
	-	-	×	×	-	-	Door closes and remains closed
"Close door" push button	-	-	-	×	-	-	Door closes and remains closed
Emergency stop switch	×	-	-	-	×	×	Door stops and can be moved freely by hand
Pharmacist button	×	×	-	-	-	-	If equipped with a toothed-belt lock, the door opens a crack in the "Night/Locked" mode of operation and remains locked in this position. Not possible for <ul style="list-style-type: none"> ▫ Rod locking ▫ Lock A
Emergency lock switch	×	-	×	-	×	-	Door closes and locks (if equipped with a lock)
							 CAUTION! Risk of injury from impact, crushing and shearing by the door when operating the emergency lock! <ul style="list-style-type: none"> ▶ Ensure that the switch for activating the emergency lock is positioned in such a way that it can only be operated by instructed persons.

*) Function only available in normal mode. If there is a fire alarm, the automatic function is deactivated and the door closes using the rubber cord.

4 Operation

4.1 Selecting the mode of operation

Automatic door systems without FR drives



GEZE recommends protection against unauthorised persons changing the modes of operation.

Automatic door systems with FR drives



Automatic door systems with FR drives must be protected against unauthorised change of modes of operation. For instance, a key switch can be used as protection or the service technician assigns a password (via ST220).

4.1.1 Selecting the mode of operation using the display programme switch DPS

- ▶ Touch the required mode of operation on the display programme switch.
- The mode of operation is set and indicated on the display (13).

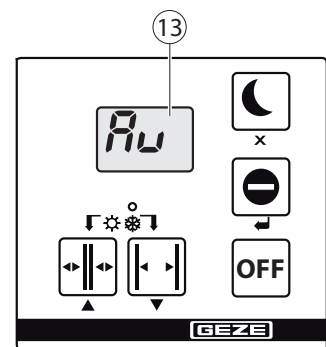



Display programme switch

Fault messages on the display

If a fault occurs in the door system, it is displayed on the display programme switch about every 10 seconds.

- ▶ Read off the number of the fault message, note it down and notify the service technician.

4.1.2 Selecting the mode of operation using the keypad programme switch TPS

- ▶ Press push buttons  and  until the desired mode of operation is set. The LED of the current mode of operation lights up.

Keypad programme switch TPS

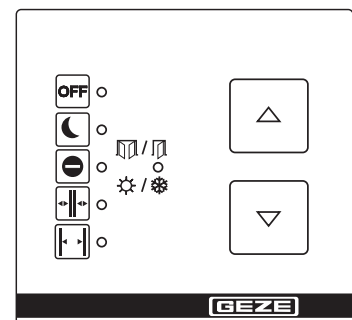

Keypad programme switch TPS

4.1.3 Selecting the mode of operation at the mechanical programme switch MPS



Not for SL-RD, SL-T30 and FR versions DUO/LL/RWS.

With the programme switch MPS

- ▶ Turn the rotary switch (14) to the required mode of operation.
The mode of operation is set.

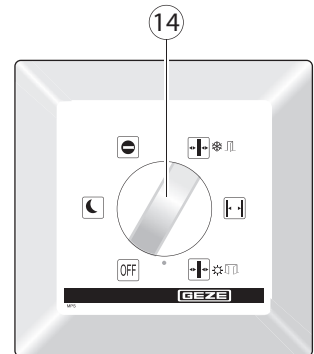

Mechanical programme switch MPS

With the programme switch MPS-ST (key switch)

Operation of the mechanical programme switch MPS-ST is only possible with the supplied key (15).

- ▶ Insert the key (15) into the mechanical programme switch MPS-ST.
- ▶ Turn the key rotary switch (16) to the required mode of operation.
The mode of operation is set.
- ▶ Remove the key.

The mechanical programme switch MPS-ST locked.

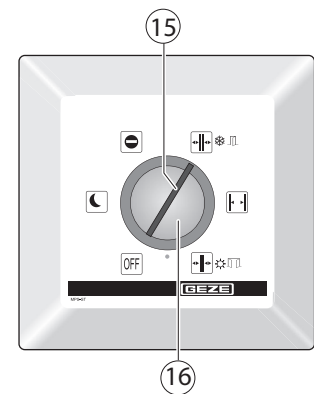

Mechanical programme switch MPS-ST with integrated key switch

4.2 Blocking and releasing modes of operation

4.2.1 With DPS and TPS – blocking/releasing with additional key switch (option 1)



With automatic standard sliding doors

- ▶ Press the key switch briefly to block function.
 - With the DPS, the function “operation blocked” is signalled by the display “- -” when any key is pressed.
 - With the TPS, the function “operation blocked” is signalled by the LED for the respectively set mode of operation flashing once when any key is pressed.
- ▶ Turn key switch again briefly for release.
Operation is then permanently released.



If operation by unauthorised persons is blocked by a password, the operation of a standard sliding door must be enabled as described in the following section “For automatic sliding doors on escape and rescue routes”. The alternative operating release, as described in the Chapter 4.2.2, is also possible. One of the operating releases is sufficient in each case.







For automatic sliding doors on escape and rescue routes

- ▶ Permanently activate the key switch in order to release the operation.
Operation is blocked as soon as the key switch is no longer pressed.
 - With the DPS, the function “operation blocked” is signalled by the display “- -” when any key is pressed.
 - With the TPS, the function “operation blocked” is signalled by the LED for the respectively set mode of operation flashing once when any key is pressed.

4.2.2 With DPS and TPS – release through password (option 2)

This requires previous setting of the 2-digit password in the drive Service menu (factory setting: no password).

Release with TPS and DPS

- ▶ Enter the first digit of the password by the number of times the key is pressed, with
 - TPS: Key ▲ 
 - DPS: Key 
- ▶ Enter the second digit of the password by the number of times the key is pressed, with
 - TPS: Key ▼ 
 - DPS: Key 
- ▶ Confirm entry for
 - TPS: Keys ▲ + ▼
 - DPS: Key 

After the password has been entered, the programme switch can be operated.

Function “operation blocked”

- Operation is blocked automatically 2 minutes after the last key has been pressed.
- With the TPS, the function “operation blocked” is signalled by the LED for the respectively set mode of operation flashing once when any key is pressed.
- With the DPS, the function “operation blocked” is signalled by the display “- -” when any key is pressed.

4.2.3 Use of the key operated programme switch MPS-ST (option 3)



The mode of operation setting can only be changed with a key.

4.3 Locking/unlocking (optional)

State	Explanation
Locking/unlocking	In the “Night/Locked” mode of operation, the door locks automatically. The door unlocks automatically when switched to every other mode of operation.
From outside	After the activation device “Authorised” has been activated, the locked door opens, closes and locks again.
No mains voltage	See Chapter 5, No mains voltage.

4.4 Behaviour in an emergency



Not for Slimdrive SL-T30.

If necessary, the door can be opened via the emergency open switch.

To return to normal operation:

- ▶ Release the emergency shut-off switch.

4.5 Behaviour at fire alarm (Slimdrive SL-T30)

Operating status	Explanation
Fire alarm	A fault F7 (fire alarm) is displayed at the programme switch. Door closes immediately with dampened closing speed and remains closed. Changing the mode of operation is not possible. Door can only be opened manually.
Normal operation	Normal operation is restored by pressing the reset switch. The reset switch can be reached by opening the drive cover.
Mains power failure	See Chapter 5, No mains voltage.

4.6 Behaviour at smoke alarm (Slimdrive SL-RD)

Operating status	Explanation
Smoke alarm	A fault F8 (smoke alarm) is displayed at the programme switch. Door closes immediately and remains closed, but is not locked. After activating the activation device "Authorised", the door opens, closes and locks again. Changing the mode of operation is not possible.
Normal operation	If the smoke detector is inactive, normal mode can be restored as follows: <ul style="list-style-type: none"> ▶ Activate the ↵ button on the display programme switch. ▶ Activate the ▲ + ▼ buttons on the keypad programme switch at the same time.
Mains power failure	See Chapter 5, No mains voltage.

4.7 Interlocking door system function

In the case of the interlocking door system function, 2 drives are connected to each other. Simultaneous opening of these 2 doors is not possible in the interlocking door system mode. The first activated door opens. As long as one door is open, the other door cannot be opened.



Simultaneous opening in the "Automatic" and "Exit only" modes of operation is not possible with activation. Only 1 door opens at a time.



The interlocking door system function is deactivated in the following cases:

- Mode of operation "Hold open"; both doors open as long as the mode of operation is active.
- Activation via "Activation device authorised" input



5 No mains voltage

 If the mains voltage fails (e.g. power failure), check the on-site safety fuse first.

5.1 Door behaviour in case of power failure

State	Reaction
No mains voltage (e.g. power failure)	<p>In the "Night/Locked" mode of operation, the door is closed and locked.</p> <p> Standard drives: In the modes of operation "Exit only", "Automatic" and "Hold open", the behaviour of the door depends on the parameters set during commissioning:</p> <ul style="list-style-type: none"> ▫ Door remains in the current position and switches off. ▫ With drives with built-in rechargeable battery depending on the function selected: <ul style="list-style-type: none"> ▫ Door closes and switches off. ▫ Door opens and switches off. ▫ Normal operation for maximum 30 minutes or 30 open/close cycles, then close and switch off. ▫ Normal operation for maximum 30 minutes or 30 open/close cycles, then open and switch off. <p> FR drives: In the "Night/Locked" mode of operation, the door is closed and locked. In the other modes of operation, the door opens and remains open.</p> <p> BO drives: In the "Night/Locked" mode of operation, the door is closed and locked. In the other modes of operation, the door opens and switches off. If the break-out function is triggered (door leaf broken out), the door remains in the current position and switches off.</p>
No active power supply (SL-T30 and SL-RD)	Door is closed with reduced closing speed in all the modes of operation.
Mains voltage available again	The door automatically returns to the last selected mode of operation.
Power supply available again (SL-T30)	The door automatically returns to the last selected mode of operation when the reset switch is pressed. The reset switch can be reached by opening the drive cover.
Power supply available again (SL-RD)	<p>The door returns to the last selected mode of operation as follows:</p> <ul style="list-style-type: none"> ▶ Activate the ← button on the display programme switch. ▶ Activate the ▲ + ▼ buttons on the keypad programme switch at the same time.

5.2 Locking/unlocking if there is no mains voltage

Locking type	Measures
Toothed belt locking	<p data-bbox="620 282 1230 320">  Locking only makes sense when the door is closed. </p> <hr/> <p data-bbox="603 376 1195 405">Locking with drives with built-in rechargeable battery</p> <p data-bbox="603 405 1302 434">▫ If the door is to be locked and this door is the only point of access:</p> <ul data-bbox="603 434 1447 602" style="list-style-type: none"> <li data-bbox="603 434 1110 463">▶ Push the door closed manually from the inside. <li data-bbox="603 463 847 492">▶ Push the locking pin. <li data-bbox="603 492 1447 602">▶ Activate the (inner) authorised activation device until initialisation of the drive is completed. DPS or TPS indicates Night/Locked mode of operation. Door opens – leave the building – door closes – locks again and switches off. <p data-bbox="603 607 1409 636">Unlocking from the outside with drives with built-in rechargeable battery</p> <ul data-bbox="603 636 1447 719" style="list-style-type: none"> <li data-bbox="603 636 1447 719">▶ Activate the (outer) authorised activation device until the drive is initialised and the door starts to open. Door opens – door closes – locks again and switches off. <p data-bbox="603 723 1398 752">Unlocking from the inside with drives with built-in rechargeable battery:</p> <ul data-bbox="603 752 1447 835" style="list-style-type: none"> <li data-bbox="603 752 1447 835">▶ Activate the (outer) authorised activation device until the drive is initialised and the door starts to open. Door opens – door closes – locks again and switches off. <p data-bbox="603 840 1417 893">Unlocking with drives without built-in rechargeable battery (only possible from the inside)</p> <ul data-bbox="603 893 1406 949" style="list-style-type: none"> <li data-bbox="603 893 1406 949">▶ Push the door to the desired locking position and push/slide the locking pin (9, Chapter 3.1). <p data-bbox="603 954 1417 1008">Unlocking with drives without built-in rechargeable battery (only possible from the inside)</p> <ul data-bbox="603 1008 987 1037" style="list-style-type: none"> <li data-bbox="603 1008 987 1037">▶ Pull the locking pin (9, Chapter 3.1). <p data-bbox="603 1037 1206 1066">The door leaves are unlocked and can be opened manually.</p>
Rod locking, Lock A and folding door lock	<p data-bbox="620 1077 1206 1115">  Locking is only possible when the door is closed. </p> <hr/> <p data-bbox="603 1171 1195 1200">Locking with drives with built-in rechargeable battery</p> <p data-bbox="603 1200 1270 1229">If the door is to be locked and this door is the only point of access:</p> <ul data-bbox="603 1229 1110 1258" style="list-style-type: none"> <li data-bbox="603 1229 1110 1258">▶ Push the door closed manually from the inside. <p data-bbox="603 1258 943 1288">For sliding door with rod locking:</p> <ul data-bbox="603 1288 1382 1344" style="list-style-type: none"> <li data-bbox="603 1288 1382 1344">▶ Lock using an Allen key through the drill hole in the cover in the indicated direction of rotation. <p data-bbox="603 1344 1409 1400">For sliding doors with Lock A (see also installation instructions “Automatic hook bolt lock Lock A”):</p> <p data-bbox="603 1400 767 1429">Manual locking:</p> <ul data-bbox="603 1429 1447 1485" style="list-style-type: none"> <li data-bbox="603 1429 1447 1485">▶ Insert a tool with approx. Ø 5 mm at the bottom into the slot of the main closing edge/side screen profile and press the lock upwards. <p data-bbox="603 1485 794 1514">Manual unlocking:</p> <ul data-bbox="603 1514 1406 1570" style="list-style-type: none"> <li data-bbox="603 1514 1406 1570">▶ Insert a tool with approx. Ø 5 mm at the top into the slot of the main closing edge/side screen profile and press the lock downwards. <p data-bbox="603 1603 1046 1632">With folding door and folding door locking:</p> <ul data-bbox="603 1632 1430 1771" style="list-style-type: none"> <li data-bbox="603 1632 1430 1688">▶ Lock with Allen key through the recess in the left post profile in the indicated direction of rotation. <li data-bbox="603 1688 1430 1771">▶ Then, activate the (inner) authorised activation device until initialisation of the drive is completed. DPS or TPS indicates Night/Locked mode of operation. Door opens – leave the building – door closes – door locks again and switches off. <p data-bbox="603 1839 1409 1868">Unlocking from the outside with drives with built-in rechargeable battery</p> <ul data-bbox="603 1868 1447 1951" style="list-style-type: none"> <li data-bbox="603 1868 1447 1951">▶ Activate the (outer) authorised activation device until the drive is initialised and the door starts to open. Door opens – door closes – locks again and switches off. <p data-bbox="603 1951 1393 1980">Unlocking from the inside with drives with built-in rechargeable battery</p> <ul data-bbox="603 1980 1393 2063" style="list-style-type: none"> <li data-bbox="603 1980 1393 2063">▶ Activate the (inner) authorised activation device until the drive is initialised and the door starts to open. Door opens – door closes – locks again and switches off.

Locking type	Measures
Rod locking, Lock A and folding door lock	<p>Unlocking with drives without built-in rechargeable battery (only possible from the inside)</p> <p>For sliding door with rod locking:</p> <ul style="list-style-type: none"> ▶ Lock using an Allen key through the drill hole in the cover in the indicated direction of rotation. <p>Sliding door with Lock A:</p> <ul style="list-style-type: none"> ▶ Fit a tool with approx. Ø 5 mm at the bottom or top of the slot in the main closing edge/side screen profile and lock in the indicated direction of movement. <p>With folding door and folding door locking:</p> <ul style="list-style-type: none"> ▶ Unlock with a hollow set-screw through the recess in the left post profile in the indicated direction of rotation until the door leaves can be pushed opened by hand.
Locking for SL-BO	<p> Locking is only possible at a closed door.</p>
	<p>Locking with drives with built-in rechargeable battery</p> <p>If the door is to be locked and this door is the only point of access:</p> <ul style="list-style-type: none"> ▶ Push the door closed manually from the inside. ▶ Push the locking pin. ▶ Activate the (inner) authorised activation device until initialisation of the drive is completed. <p>DPS or TPS indicates Night/Locked mode of operation. Door opens – leave the building – door closes – door locks again and switches off.</p> <p>Unlocking from the outside with drives with built-in rechargeable battery</p> <ul style="list-style-type: none"> ▶ Activate the (outer) authorised activation device until the drive is initialised and the door starts to open. <p>Door opens – door closes – door locks again and switches off.</p> <p>Unlocking from the inside with drives with built-in rechargeable battery</p> <ul style="list-style-type: none"> ▶ Activate the (inner) authorised activation device until initialisation of the drive is completed. <p>Unlocking with drives without built-in rechargeable battery (only possible from the inside)</p> <ul style="list-style-type: none"> ▶ Push the door to the desired locking position and push the locking pin (9, Chapter 3.1). <p>Unlocking with drives without built-in rechargeable battery (only possible from the inside)</p> <ul style="list-style-type: none"> ▶ Pull the locking pin (9, Chapter 3.1). <p>The door leaves are unlocked and can be opened manually.</p>



After the mains voltage has been restored, the (locked) door automatically switches to the “Night/Locked” mode of operation.

6 Fault messages

6.1 Keypad programme switch TPS/Display programme switch DPS

Display keypad programme switch					Designation	Display display programme switch
OFF						
-	-	-	-	-	No operating voltage	
-	-	-	x	x	Drive too hot	45, 46, 48, 75, 78
-	-	x	-	x	Position	26, x.x
-	-	x	x	-	SIS	13, 19
-	-	x	x	x	Motor	10, 11, 12, 71, 72
-	x	-	-	x	Activation longer than 4 min	35, 36, 37, 38, 39, 40
-	x	-	x	x	Interlocking door system, vestibule	33
-	x	x	-	-	Rechargeable battery	61
-	x	x	x	-	Opening time too long	64
x	-	-	-	x	Alarm	07, 08, 32, 42, 44
x	-	-	x	x	DCU104	50
x	-	x	-	-	SIO, BO	27, 29, 41
x	x	-	-	-	Mains power failure	03
x	x	-	-	-	control	01, 02, 28, 47, 60, 63, 65, 70, 77, 79
x	x	x	-	-	Locking	16, 17, 18, 51, 53
x	x	x	-	x	Communication	15, 34, 54, 55

6.2 Mechanical programme switch MPS/MPS-ST

If a fault occurs in the system, this is indicated by the LED lighting up permanently.







- ▶ Notify a service technician.

7 What to do if...?

Problem	Cause	Remedy
Door only opens and closes slowly	Floor guide area dirty	▶ Disconnect power supply (e.g. fuse provided by customer). ▶ Clean floor guide area.
	Obstruction in travel path	▶ Remove obstruction and check door leaf for ease of movement.
	Closing safety sensor (SIS) interrupted or misaligned	▶ Clean closing safety sensor (SIS) (photoelectric barrier). ▶ Check settings of light curtain.
Door opens and closes constantly	Obstruction in sliding path, e.g. stone in floor guide area	▶ Disconnect power supply (e.g. fuse provided by customer). ▶ Clear obstruction and clean floor guide area.
	Light beams or reflections, e.g. reflective floor, drops of rain, plants / flower pots, posters/displays or similar in the scanned area of the movement detector	▶ Check detection area of movement detectors.
	Misaligned movement detector	▶ Check detection area of movement detectors.
Door only opens a crack	Obstruction in travel path	▶ Remove obstruction and check door leaf for ease of movement.
Door does not open	Obstruction in travel path	▶ Remove obstruction and check door leaf for ease of movement.
	Movement detector misaligned or defective (inside and/or outside)	▶ Check movement detector.
	Mode of operation "Night/Locked", "Off"	▶ Select a different mode of operation.
	"Exit only" mode of operation	▶ Select "Automatic" mode of operation.
	Floor locks are locked	▶ Unlock floor locks.
	Lock M is locked	▶ Unlock hook bolt lock.

Problem	Cause	Remedy
	No mains voltage (e.g. power failure)	See Chapter 5, No mains voltage
	Fire alarm (SL-T30)	See Section 4.5, Behaviour at fire alarm
	Smoke alarm (SL-RD)	See Section 4.6, Behaviour at fire alarm
	Only for BO drives: Side panel is not latched in (error messages 27, 29 and 41)	▶ Latch the side panel in.
Door closes automatically	Fire alarm (SL-T30)	See Section 4.5, Behaviour at fire alarm
	Smoke alarm (SL-RD)	See Section 4.6, Behaviour at fire alarm
Door does not unlock or lock	Locking defective	Unlock/lock the door manually: ▶ Check lock in the "Night/Locked" mode of operation. If the locking is defective: ▶ Notify a service technician.
Door does not close	Closing safety sensor (SIS) interrupted or misaligned	▶ Clean the closing safety sensor (SIS). ▶ Check settings of light curtain.
	Obstruction in travel path	▶ Remove obstruction and check door leaf for ease of movement.
	Movement detector triggers constantly	▶ Check movement detector.
	"Hold open", "Off" mode of operation	▶ Select a different mode of operation.
	No mains voltage (e.g. power failure)	See Chapter 5, No mains voltage.
Programme switch cannot be operated	Programme switch is blocked Programme switch is defective	▶ Activate key switch. ▶ Enter password. ▶ Request servicing.
Fault messages displayed at programme switch	Fault in the door system	See Chapter 6, Fault messages

Carry out a reset/delete the fault memory

- With keypad programme switch:
 - ▶ Use key  or  to change to the mode of operation "Off" (see Chapter 4.1).
 - ▶ Press keys  and  simultaneously for 1 s.
- DPS with OFF key:
 - ▶ Set mode of operation "Off".
 - ▶ Activate keys  +  simultaneously for 1 s.

The fault memory is deleted.

- ▶ Re-select mode of operation.

8 Cleaning and maintenance

8.1 Cleaning

- ⚠ WARNING!**
Risk of electric shock due to improper cleaning!
 ▶ Doors should only be cleaned by trained personnel.

- ⚠ CAUTION!**
Danger of injury due to impact and crushing!
 ▶ Set the mode of operation to "Off".
 ▶ Secure door leaves against accidental movement before carrying out cleaning work.
 ▶ Cleaning should only be carried out by persons who have been instructed in the safety devices.
 ▶ Mark the door accordingly during cleaning.
 ▶ During cleaning work, secure the system against unauthorised switching of the mode of operation.

What is to be cleaned	How is it to be cleaned
Safety sensor	Wipe with moist cloth.
Glass surfaces	Wipe with a suitable glass cleaner and dry.
Stainless surfaces	Wipe with non-scratching cloth.
Coated surfaces	Wipe with water and soap.
Anodised surfaces	Wipe with non-alkaline potassium soap (pH value 5.5...7).
Programme switch	Wipe with damp cloth. Do not use a cleaning agent.

8.2 Maintenance

- !** The owner must ensure that the system is working perfectly. In order to ensure faultless operation, the door system has to be maintained by a service technician when the maintenance indicator lights up.
 ▶ Slimdrive SL T30 must be permanently ready to use. The operator is responsible for checking its functioning at least once a month.

The maintenance displays are located at the programme switches. The version differs depending on the programme switch used:

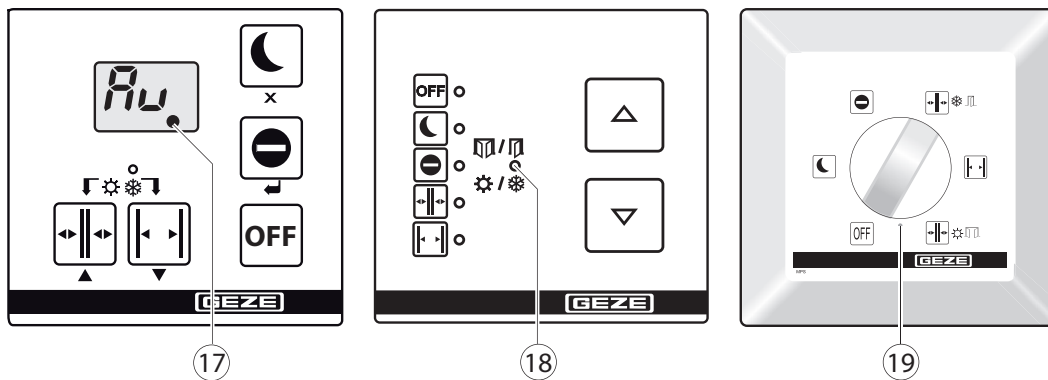

Programme switch	Maintenance indicator
Display programme switch	A red dot (17) appears at the bottom right of the display (also refer to Chapter 3.3.1).
TPS	"Reduced opening width" LED (18) flashes.
MPS, MPS-ST	LED (19) flashes.

The maintenance display lights up after the specified calendar period or number of opening cycles, depending on what occurs first:

Door system	Calendar period	Opening cycles
Standard	1 year	500,000
FR variant		
RD variant	1 year	200,000
T30 variant	½ year	200,000

GEZE offers maintenance contracts with the following services:

- Cleaning and readjustment of roller carriage and tracks
- Inspection and adjustment of toothed belts
- Inspection of door suspension plate and floor guide
- Inspection of fixing elements for firm fit
- Performance of miscellaneous adjustment work
- Performance of operational checks
- Perform function test for SL-RD and SL-T30

8.3 Rechargeable battery



Information regarding the Battery Directive:

(Applicable in Germany and all other countries in the European Union, together with the country's own regulations of a separate old battery-return system.)

In accordance with the Battery Directive, we are obliged to inform you of the following in connection with the sale of batteries or rechargeable batteries respectively in connection with the delivery of devices containing batteries or rechargeable batteries:

Rechargeable batteries and batteries must not be disposed of with household waste. Disposal with household waste is expressly forbidden according to the Battery Directive. As the end-consumer, you are legally obliged to return used batteries. Please dispose of batteries at a municipal collection point or in store. Batteries obtained from us can be returned to us by mail. The address is:

GEZE GmbH, Goods reception, Reinhold-Vöster-Str. 21-29, D-71229 Leonberg.



Batteries that contain hazardous substances are labelled with the symbol of a crossed-out garbage can. The chemical identifier of the harmful chemical, Cd for cadmium, Pb for lead, Hg for mercury, is located under the garbage can symbol.



Automatic sliding door systems from GEZE contain NiCd rechargeable batteries. NiCd rechargeable batteries must be replaced after 2 years at the latest.

9 Safety-related inspection by trained professionals

In compliance with

- DIN 18650-2 "Powered pedestrian doors – Part 2: Safety at powered pedestrian doors", Section 5 and
- EN 16005 "Power operated pedestrian doorsets", Chapter 4.2.1

the safe condition of power operated doors must be checked before initial commissioning and once a year by a professional authorised by GEZE.

GEZE offers the following services:

Inspection and functional checks of all safety and control equipment in compliance with the requirements in the test log for power-operated windows, doors and gates; sliding doors and sliding gates BGG 950 (ZH 1/580.2) edition.

10 Technical data

- | | |
|--------------------------------|--|
| ▫ Opening speed | 0.03 m/s ... 0.8 m/s |
| ▫ Closing speed | 0.03 m/s ... 0.8 m/s |
| ▫ Electrical connection values | 230 V; 50 Hz according to DIN IEC 60038 |
| ▫ Connected load | max. 300 VA
(Powerdrive PL: max. 450 VA) |
| ▫ Fuse protection | Power supply connection 230 V, on site 10 A |
| ▫ Current for external devices | 24 V DC connection; max. 1000 mA |
| ▫ Accumulator specifications | 24 V; 700 mAh |
| ▫ Temperature range | -15 °C to +50 °C;
only for dry rooms
Slimdrive SL-T30: +10 °C to +50 °C
Slimdrive SL-RD: +10 °C to +50 °C |
| ▫ IP rating | IP 20 |

Subject to change

Germany
GEZE GmbH
Niederlassung Süd-West
Tel. +49 (0) 7152 203 594
E-Mail: leonberg.de@geze.com

GEZE GmbH
Niederlassung Süd-Ost
Tel. +49 (0) 7152 203 6440
E-Mail: muenchen.de@geze.com

GEZE GmbH
Niederlassung Ost
Tel. +49 (0) 7152 203 6840
E-Mail: berlin.de@geze.com

GEZE GmbH
Niederlassung Mitte/Luxemburg
Tel. +49 (0) 7152 203 6888
E-Mail: frankfurt.de@geze.com

GEZE GmbH
Niederlassung West
Tel. +49 (0) 7152 203 6770
E-Mail: duesseldorf.de@geze.com

GEZE GmbH
Niederlassung Nord
Tel. +49 (0) 7152 203 6600
E-Mail: hamburg.de@geze.com

GEZE Service GmbH
Tel. +49 (0) 1802 923392
E-Mail: service-info.de@geze.com

Austria
GEZE Austria
E-Mail: austria.at@geze.com
www.geze.at

Baltic States –
Lithuania / Latvia / Estonia
E-Mail: baltic-states@geze.com

Benelux
GEZE Benelux B.V.
E-Mail: benelux.nl@geze.com
www.geze.be
www.geze.nl

Bulgaria
GEZE Bulgaria - Trade
E-Mail: office-bulgaria@geze.com
www.geze.bg

China
GEZE Industries (Tianjin) Co., Ltd.
E-Mail: chinasales@geze.com.cn
www.geze.com.cn

GEZE Industries (Tianjin) Co., Ltd.
Branch Office Shanghai
E-Mail: chinasales@geze.com.cn
www.geze.com.cn

GEZE Industries (Tianjin) Co., Ltd.
Branch Office Guangzhou
E-Mail: chinasales@geze.com.cn
www.geze.com.cn

GEZE Industries (Tianjin) Co., Ltd.
Branch Office Beijing
E-Mail: chinasales@geze.com.cn
www.geze.com.cn

France
GEZE France S.A.R.L.
E-Mail: france.fr@geze.com
www.geze.fr

Hungary
GEZE Hungary Kft.
E-Mail: office-hungary@geze.com
www.geze.hu

Iberia
GEZE Iberia S.R.L.
E-Mail: info.es@geze.com
www.geze.es

India
GEZE India Private Ltd.
E-Mail: office-india@geze.com
www.geze.in

Italy
GEZE Italia S.r.l
E-Mail: italia.it@geze.com
www.geze.it

GEZE Engineering Roma S.r.l
E-Mail: italia.it@geze.com
www.geze.it

Korea
GEZE Korea Ltd.
E-Mail: info.kr@geze.com
www.geze.com

Poland
GEZE Polska Sp.z o.o.
E-Mail: geze.pl@geze.com
www.geze.pl

Romania
GEZE Romania S.R.L.
E-Mail: office-romania@geze.com
www.geze.ro

Russia
OOO GEZE RUS
E-Mail: office-russia@geze.com
www.geze.ru

Scandinavia – Sweden
GEZE Scandinavia AB
E-Mail: sverige.se@geze.com
www.geze.se

Scandinavia – Norway
GEZE Scandinavia AB avd. Norge
E-Mail: norge.se@geze.com
www.geze.no

Scandinavia – Denmark
GEZE Danmark
E-Mail: danmark.se@geze.com
www.geze.dk

Singapore
GEZE (Asia Pacific) Pte, Ltd.
E-Mail: gezesea@geze.com.sg
www.geze.com

South Africa
GEZE South Africa (Pty) Ltd.
E-Mail: info@gezesa.co.za
www.geze.co.za

Switzerland
GEZE Schweiz AG
E-Mail: schweiz.ch@geze.com
www.geze.ch

Turkey
GEZE Kapı ve Pencere Sistemleri
E-Mail: office-turkey@geze.com
www.geze.com

Ukraine
LLC GEZE Ukraine
E-Mail: office-ukraine@geze.com
www.geze.ua

United Arab Emirates/GCC
GEZE Middle East
E-Mail: gezeme@geze.com
www.geze.ae

United Kingdom
GEZE UK Ltd.
E-Mail: info.uk@geze.com
www.geze.com

GEZE GmbH
Reinhold-Vöster-Straße 21–29
71229 Leonberg
Germany

Tel.: 0049 7152 203 0
Fax.: 0049 7152 203 310
www.geze.com

